



Refrigeration **excellence** since 1962



COOLING ASSEMBLY **Zero Z120b**

USER MANUAL

TRANSLATION OF THE ORIGINAL
INSTRUCTIONS



REVISION

DATE	REVISION	DESCRIPTION
02/2022	01	First version

The information contained in this manual is the property of ZANOTTI S.p.A.

The drawings and other documents accompanying the refrigeration unit are the property of ZANOTTI S.p.A.

It is forbidden to distribute and/or duplicate, in any form, this manual, even partially, without the written authorisation of ZANOTTI S.p.A.

ZANOTTI S.p.A. reserves the right to change, without prior notice, the characteristics of the product described in this manual.

In case of doubt or difficulty in understanding or interpreting the manual, the original/official version indicated as "ORIGINAL INSTRUCTIONS" on the cover, must be considered as the valid version.

The contents of this manual have been carefully checked to ensure they correspond to the system in question.

However, as possible differences cannot be excluded, the contents of this document are periodically checked and any corrections or modifications will be included in the next edition.

Some of the images included in this manual should only be considered as an example, as they may not refer to the refrigeration unit described here.

1	GENERAL INFORMATION.....	6
1.1	Introduction	6
1.2	Service	6
1.3	Symbols	7
1.4	Manufacturer's contact details.....	8
1.5	Safety standards	8
1.6	Manufacturer's responsibility	8
1.7	Management of the refrigeration unit.....	9
1.8	Warranty.....	9
2	Safety	10
2.1	General information.....	10
2.1.1	Refrigeration unit certification	11
2.1.2	Refrigeration unit identification	12
2.2	Intended and unintended uses	13
2.3	Environmental operating conditions	13
2.3.1	Fire extinguishing system.....	13
2.3.2	Explosive Atmosphere.....	13
2.3.3	Vibrations	13
2.3.4	Noise	14
2.3.5	Electromagnetic emissions.....	14
2.4	Disposal of used materials	14
3	Description.....	15
3.1	Loading of goods.....	16
3.1.1	Before loading goods	16
3.1.2	When loading goods.....	16

3.2	Operation.....	18
3.2.1	Operating in "Road" mode.....	18
3.2.2	Operation in "External power supply" mode (optional).....	18
3.2.3	Defrosting.....	18
3.2.4	Heating (optional).....	19
4	Use	20
4.1	In-cab controller.....	20
4.1.1	Control description.....	21
4.1.2	On/Off unit.....	22
4.1.3	Setting the work point.....	24
4.1.4	Manual Defrost.....	24
4.2	Alarms and warnings.....	25
4.2.1	Alarm archive.....	25
4.2.2	Alarm cancellation.....	26
4.2.3	List of alarms and warnings.....	27
4.3	Changing the operating parameters.....	31
5	Maintenance	32
5.1	ROAD MODE Service Program (SEr warning).....	32
5.2	EXTERNAL POWER SUPPLY MODE Service Program (SEe Report).....	32
5.3	List of interventions.....	33
6	Appendix.....	34
6.1	Basic Troubleshooting.....	34
6.2	Removal and mounting of the flaps of the condenser unit.....	35
6.2.1	Removal.....	35
6.2.2	Assembly.....	36

6.3	Fuses	37
6.3.1	Fuse List.....	38

1 GENERAL INFORMATION

1.1 Introduction



NOTE

ZANOTTI S.p.A., the manufacturer of this refrigeration unit in question is referred to in the manual as **Manufacturer**.



NOTE

The company that purchased the refrigeration unit is referred to in the manual as **Customer**.

This manual contains all the information necessary for correct use and maintenance of the refrigeration unit.

This document represents the user manual of refrigeration unit **Zero Z120b** and is completed in accordance with EEC Directive 2006/42.



This manual is to be regarded as an integral part of the refrigeration unit and must be kept until final disposal.

1.2 Service

For technical service, contact the manufacturer's service centre directly.

1.3 Symbols

The manual uses some symbols which are used to draw the reader's attention and highlight some particularly important aspects.

SYMBOL	MEANING	NOTES
	DANGER	It indicates a risk of injury to the user. Pay close attention to the text blocks indicated by this symbol.
	CAUTION	It is a warning of possible deterioration or damage to the refrigeration unit. Pay attention to the text blocks indicated by this symbol.
	WARNING NOTE	It indicates a warning or a note on key functions or useful information. Pay attention to the text blocks indicated by this symbol.

1.4 Manufacturer's contact details

For any type of information or clarification regarding use, etc., the Manufacturer's Technical Office is always at the disposal of the Customer's requests.

The latter should ask questions in clear terms, with references to this manual, always indicating the data on the identification plate of the refrigeration unit in question.

Any request for intervention, from the Customer's service department, or for clarification regarding the technical aspects of this document, must be addressed to:

Zanotti S.p.A.
Via M. L. King, 30
46020 Pegognaga (MN) Italy
Phone +39 0376 5551
E-mail: info@zanotti.com

1.5 Safety standards

This manual provides instructions, indications, standards, and safety notes which are intended to define a series of behaviours and obligations that must be followed in carrying out the various activities intended for use of the refrigeration unit in order to ensure personnel, equipment, and the surrounding environment are protected.

The safety standards are aimed at all personnel authorised, trained and delegated to perform the various tasks and activities of:

- Operation
- Use
- Management

1.6 Manufacturer's responsibility

The manufacturer cannot be held responsible for improper or incorrect use of the refrigeration unit, for damage resulting from the use of non-authorised spare parts or tampering with circuits, components and software.

The responsibility for the implementation of the safety precautions, listed below, is borne by the technical personnel responsible for the activities envisaged on the refrigeration unit.

It is the installer's responsibility to ensure that the operators (authorised to perform the required activity) are qualified, adhere to, and are aware of all the requirements of this document as well as the general safety standards applicable to the refrigeration unit.

Failure to observe the safety standards can cause injury to personnel and damage to the equipment.

1.7 Management of the refrigeration unit

The management of the refrigeration unit is only permitted to authorised and properly trained operators.

The operators in charge of the use of the refrigeration unit must be aware that knowledge and application of the safety standards is an integral part of their work.

Before starting the refrigeration unit it is necessary to:

- read this manual carefully.
- know which guards and emergency stop devices are on the refrigeration unit, where they are located and how they work.

It is prohibited to remove, even partially, the safety guards and devices located on the refrigeration unit.

The same standard applies to the warning plates.

The safety guards and devices must be kept in perfect order to ensure proper operation. In the event of a malfunction or breakdown of these devices, contact the Manufacturer's Technical service immediately.

1.8 Warranty

The Manufacturer warrants his products from defects in materials and manufacture for a period of 24 months from the date of delivery.

The purchaser is only entitled to the replacement of the defective parts; the costs of packing, transport and any installation shall be borne by the manufacturer. In this case, the following shall be specified:

- Date and number of the purchase document.
- Refrigeration unit model.
- Serial number.

Claims for damages due to non-use or long periods of inactivity of the refrigeration unit will not be accepted.

Damage for use not in accordance with this manual is excluded from the warranty.

The warranty will not be recognised for machines where unauthorised modifications have been made. In any case, modifications or tampering with safety devices are strictly prohibited.

In the case of repairs during the warranty period, it is necessary to use original spare parts in order not to affect their validity.

Repair work must only be carried out by specialised operators, who are familiar with the refrigeration unit.

2 SAFETY

2.1 General information

The Customer must provide personnel with training on the risks of injury, on the safety devices installed on the refrigeration unit and on the general accident prevention rules in the European Union and local regulations.

The operators must know the position and operation of all the controls of the refrigeration unit and their characteristics.

In addition, they must have read and fully understood the contents of this manual.

By tampering with, or unauthorised replacement of, one or more components of the refrigeration unit, adopting accessories that modify its use, and using spare parts other than those recommended, there is a risk of injury.



DANGER

It is absolutely forbidden to by-pass/tamper with the safety devices on the refrigeration unit. The Manufacturer accepts no responsibility for the safety of the refrigeration unit in case of non-compliance with this prohibition.



DANGER

In the event of an intervention on the plant, only use bypass hoses in good condition and avoid letting them come into contact with belts, pulleys, or fans.



DANGER

Avoid putting your hands near the fans and the belts when the unit is operating.



DANGER

The coolant liquid is under pressure. Any intervention into the refrigeration circuit must only be carried out by authorised personnel. To prevent accidental spillages of liquid, do not open the caps of the tanks.



DANGER

Disconnect the plug and ensure that the refrigeration unit is turned off before performing maintenance. In case of prolonged maintenance, disconnect the battery.



DANGER

Battery acid causes burns. The batteries contain sulphuric acid.

Avoid contact with skin, eyes or clothing.

In case of accidental contact with the skin, rinse with water.

In case of accidental contact with the eyes, rinse with water for 15 minutes and consult a doctor immediately.

In the event of an accidental ingestion, you should consume large quantities of water or milk. Do not induce vomiting. Consult a doctor immediately.

Failure to comply may result in death or serious injury.



DANGER

The battery could explode!

To prevent an explosion:

- Always unplug the negative battery cable (-) first.
- Always connect the negative battery cable (-) last.
- Do not short-circuit the battery ends with metal objects.
- Do not weld, mould or smoke near a battery.

Failure to comply may result in death or serious injury.

2.1.1 Refrigeration unit certification

The refrigeration unit is provided with the EC Declaration of Conformity with the essential safety requirements in accordance with Machine Directive 2006/42/EC (Annexe II A) and the Electromagnetic Compatibility Directive 2014/30/EU.



NOTE

Any changes made to the refrigeration unit will immediately invalidate the EC certification issued by the manufacturer.

2.1.2 Refrigeration unit identification

the model and serial number (or registration number) are shown on the metal plate attached to the side of the unit (Figure 1) and to the electrical panel (Figure 2).

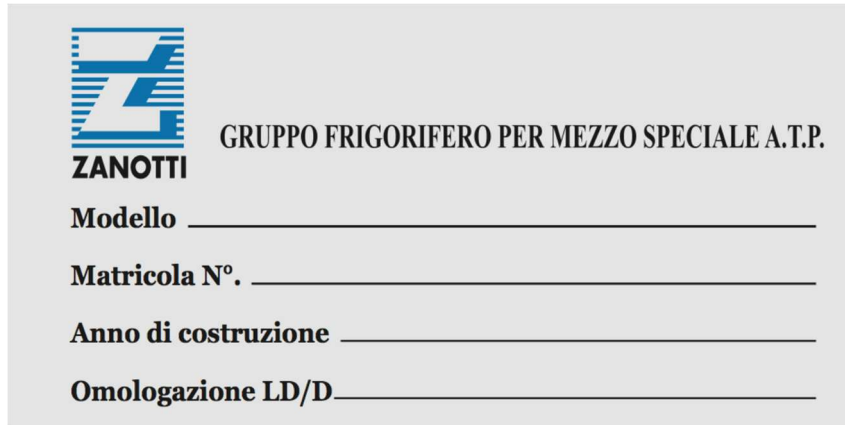

ZANOTTI
GRUPPO FRIGORIFERO PER MEZZO SPECIALE A.T.P.

Modello _____

Matricola N°. _____

Anno di costruzione _____

Omologazione LD/D _____

Figure 1 - Metal plate

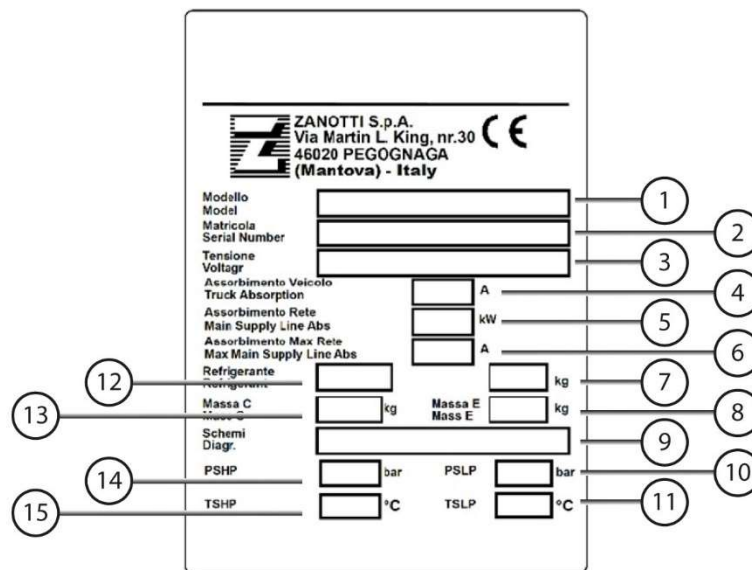

Figure 2 - Plate on the electrical panel

- | | | | |
|---|-------------------------------|----|--------------------------|
| 1 | Model identification | 9 | Code of wiring diagrams |
| 2 | Serial number | 10 | Low LP pressure (bar) |
| 3 | Nominal voltage (V) | 11 | Low LP temperature (°C) |
| 4 | Vehicle absorption (A) | 12 | Coolant type |
| 5 | Power consumption (A) | 13 | Condenser mass (kg) |
| 6 | Maximum power consumption (A) | 14 | HP high pressure (bar) |
| 7 | Coolant quantity (kg) | 15 | HP high temperature (°C) |
| 8 | Evaporator mass (kg) | | |

2.2 Intended and unintended uses

The unit in question was designed and built to be installed in motor vehicles intended for the transportation of refrigerated products, or, more generally, for the transportation of goods for which temperature control is required.



DANGER

The use of the refrigeration unit for purposes and processes not described in this manual constitutes **IMPROPER USE**. The Manufacturer declines any and all responsibility for any damage caused to property and/or persons and considers that any form and type of guarantee of the refrigeration unit has lapsed. The Manufacturer accepts no responsibility for tampering with the refrigeration unit, for unauthorised modifications or for maintenance operations carried out by untrained personnel.



DANGER

In case of abnormal operation or lack of supply, it is forbidden to carry out any procedure. These interventions are reserved only for operators assigned to maintenance.

2.3 Environmental operating conditions

2.3.1 Fire extinguishing system

The refrigeration unit is not equipped with its own fire extinguishing system.

In accordance with local regulations, the customer must make sure the fire extinguishing devices on the vehicle where the refrigeration unit is installed are present and functioning properly.

Flammable liquids do not circulate freely in the refrigeration unit.

2.3.2 Explosive Atmosphere

The refrigeration unit is not designed and manufactured to work in environments with an explosive or partially explosive atmosphere.

2.3.3 Vibrations

The refrigeration unit does not produce vibrations which are dangerous to the health of the staff in charge.



CAUTION

Excessive vibration can only be caused by a mechanical fault, which must be immediately reported and eliminated, in order not to jeopardise the safety of the refrigeration unit and of the staff in charge.

2.3.4 Noise

The noise level testing has been carried out in accordance with the requirements of UNI EN ISO 9614-2 acoustics.

Typical phonometric data are stored by the Manufacturer.

The sound power generated is indicated on a label located on the door of the electrical panel.



NOTE

The measurements of the noise exposure levels of the persons in charge shall be carried out by the users, in accordance with the local regulations.

2.3.5 Electromagnetic emissions

The refrigeration unit contains electronic components subject to Electromagnetic Compatibility legislation, conditioned by conducted and irradiated emissions.

Emission values conform to the standard through the use of components complying with the Electromagnetic Compatibility Directive, suitable connections and installation of filters where necessary.

The refrigeration unit therefore complies with the Electromagnetic Compatibility (EMC) Directive.

2.4 Disposal of used materials

The refrigeration unit, in its normal operation and in the absence of defects, does not produce any used material.

It is necessary to periodically check for leaks in the coolant circuit, in accordance with the correct procedure to avoid any dispersion.

The filter drier is a material that must be replaced regularly in accordance with the scheduled maintenance plans in this manual. It must not be disposed of in the environment, but must be disposed of in accordance with local directives. The customer must be aware of this fact and operate in such a way as to comply with it.

The refrigeration unit and its packaging must be disposed of in accordance with local laws and regulations. As this unit is composed of an engine and electronic components, the refrigeration unit and its accessories must be disposed of separately from general solid urban waste at the end of its life cycle. Contact your local authority for information on disposal and recycling.



3 DESCRIPTION

The refrigeration unit has been designed and built to be installed on motor vehicles for the refrigerated transport of fresh and frozen products.

The Z120b refrigeration unit is powered by the vehicle battery, and consists of the following parts (Figure 3):

1. Condenser unit, installed outside the isothermic crate.
2. Evaporative unit installed inside the isothermic crate.
3. Electronic control and command power unit (HMI) , located inside the vehicle cab (in-cab controller).

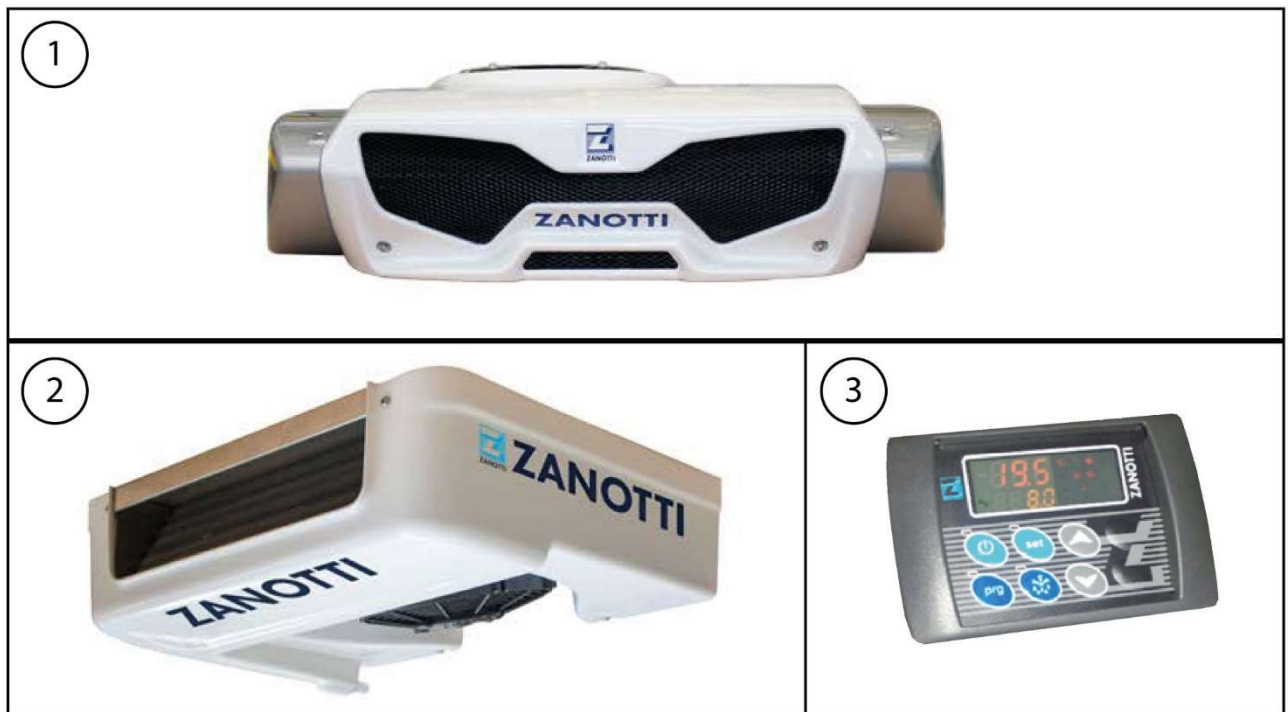

Figure 3 - Zero Refrigeration unit Z120b

- 1 Condenser unit
- 2 Evaporator

- 3 In-cab controller

3.1 Loading of goods



NOTE

The refrigeration system is designed to keep the temperature of the goods being loaded constant. It is not designed to refrigerate hot products.

It is therefore extremely important to check the temperature of the goods during loading to ensure that they are at the ideal transport temperature.

Maintaining the quality of the goods during transport depends on the correct air circulation (and thus on the uniform temperature distribution) in the insulated cold room.

The lack of free movement of air leads to pockets of heat or to ice formation.

For this reason, it is advisable to use pallets that will promote the free movement of air, protecting goods from heat coming from the floor of the trailer.

It is also important to position the goods away from the walls of the insulated cold room in order to ensure correct air circulation.

Products such as fruit and vegetables, which generate heat, must be stacked to ensure sufficient space for the removal of the heat generated.

Products such as meat and frozen food, which do not generate heat, must be stacked in the centre of the cold room close to each other.

3.1.1 Before loading goods

- Cool the cold room in advance before loading the goods. Power on the unit before loading.
- If the temperature reaches 4°C, it is recommended that the evaporating battery is defrosted from the presence of ice in order to increase its efficiency.

3.1.2 When loading goods



NOTE

The loading of goods must be carried out with the system off.

- Reduce the opening times of the cold room doors, to avoid the entrance of hot air and humidity.
- Depending on the products to be transported, select the temperature via the HMI in-cab controller (see 4.1.3).

- Promote air circulation without obstructing the air suction and air supply openings (Figure 4).

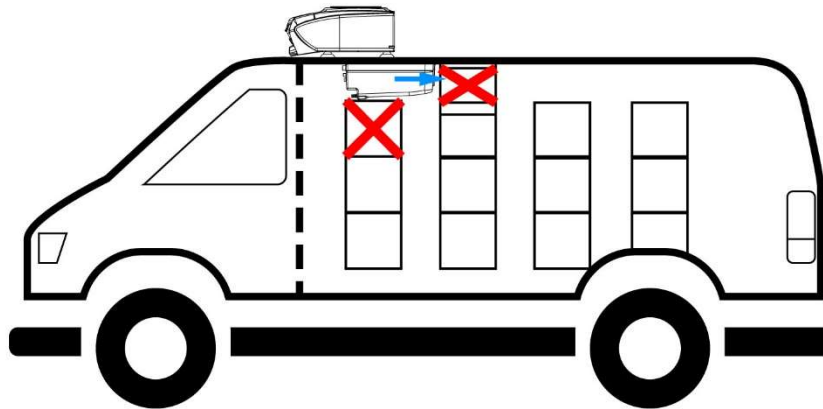

Figure 4 - Covered suction and ventilation ducts

- Leave a free space of about 6 - 8cm between the load and the front wall and about 20cm between the top of the load and the roof (Figure 5).
- Leave a free space even between the floor and the load.

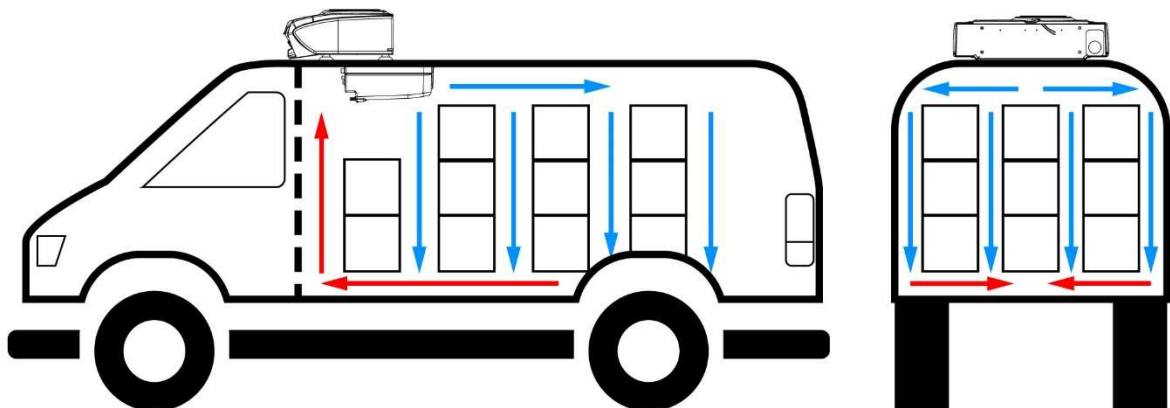

Figure 5 - Air circulation inside the cold room



DANGER

The transport cold rooms do not need to be opened from the inside. Before closing the doors of the cold room, make sure that no one is inside it.



CAUTION

During rest periods, it is recommended to place the cold room in the shadows.



CAUTION

Never leave a system unused for more than a month.

3.2 Operation

3.2.1 Operating in "Road" mode

The refrigeration unit is connected to the vehicle battery, which provides 12 VDC power to the DC motor and the components of the refrigeration circuit.

The unit is completely autonomous with respect to the vehicle on which it is installed and can operate even during rest periods.

3.2.2 Operation in "External power supply" mode (optional)

On request, it is possible to connect the unit via a plug to the mains ("External power supply" mode).

The power supply to the motor in this mode is 220-230 VAC, single phase, or 400 VAC, three phase, depending on the model installed.



CAUTION

The "External power supply" option is a dimensioned operating mode for occasional and non-intensive use. It cannot be considered as a replacement for a system with a fixed cold room, without having the same technical characteristics.

3.2.3 Defrosting

Because of the cooling it is subjected to, the air releases moisture that accumulates while gradually freezing on the fins of the evaporator. This would result in a progressive obstruction of the circulation of air resulting in a reduction in the efficiency of the system.

Over time, this could also cause damage.

As a result, the hydraulic unit periodically performs defrosting cycles to reduce the accumulation of ice, thereby avoiding the problems mentioned above. The water is discharged externally.

The in-cab controller manages autonomously and periodically the beginning and end of the defrosting.

During the defrosting phase, "hot gas" is exploited, i.e. the heat created by the compression of the refrigerant gas is diverted directly into the evaporator to melt the accumulated ice.

Tips

The efficiency of the defrosting is inextricably linked to the accuracy with which the water discharge line generated as a result of the ice melting is achieved. Therefore:

- Make sure that the slope of the discharges is such as to ensure the correct flow of condensation.
- Periodically check the water outflow from the condensate drain hose.
- Minimise the cold room openings and switch off the unit during loading and unloading of the goods, in order to minimise the inlet of damp external air.
- In case of intensive use of the unit, regularly check the accumulation of ice in the evaporator and, if necessary, perform manual defrosting by holding down the defrost button  for 5 seconds.

3.2.4 Heating (optional)

In case of particularly low ambient temperatures (in certain circumstances and/or periods of the year), it may be necessary to heating the cold room as an alternative to keeping it cool.

This, in order to maintain the correct temperature of the product, regardless of the external conditions for the entire necessary period.

This occurs, for example, in the case of transporting foil flowers or plants for which a temperature between 5 and 10°C (41-50°F) must be guaranteed, even when the external temperature falls below zero.

From a technical point of view, the heating uses the same principles as for the hot gas defrosting described above.

In the event that the set-point temperature of the cold room exceeds that measured, the unit automatically switches to the heating mode if required by the operating conditions.

4 USE

4.1 In-cab controller

The main control unit, located inside the vehicle cab (in-cab controller), allows the management and monitoring of the unit.

Setting the Set-Point temperature (see 4.1.3), the unit performs the temperature control autonomously.



Figure 6 - In-cab controller

4.1.1 Control description

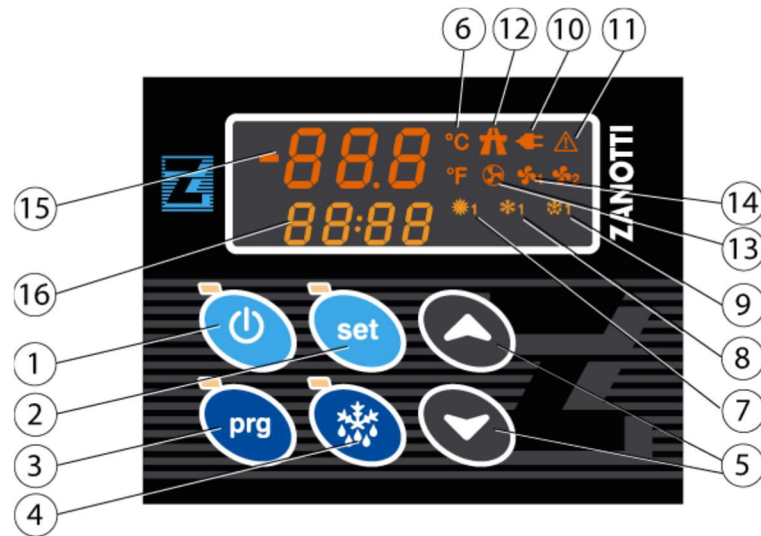



Figure 7 – Main control unit controls (in-cab controller)

- | | |
|--|--|
| <p>1 ON/OFF KEY</p> <p>2 SET KEY</p> <p>3 PROGRAMMING KEY</p> <p>4 MANUAL DEFROSTING KEY</p> <p>5 UP/DOWN KEYS</p> <p>6 LED °C OR °F</p> <p>7 HOT LED</p> <p>8 COLD LED</p> <p>9 DEFROST LED</p> <p>10 EXTERNAL POWER SUPPLY MODE LED</p> <p>11 ALARM LED</p> <p>12 ROAD MODE LED</p> <p>13 CONDENSER FAN LED</p> <p>14 EVAPORATOR FAN LED</p> <p>15 TEMPERATURE DISPLAY</p> <p>16 ALARM DISPLAY</p> | <p>Switching the unit on or off (by pressing it for 3"). The red LED lit indicates the presence of voltage.</p> <p>Setting the working set-point of the unit. The LED on allows setting.</p> <p>Access to the programming (by pressing it for 5"). The LED on allows programming.</p> <p>Forced activation of the defrosting cycle (by pressing it for 5"). The LED lit indicates the active defrosting phase.</p> <p>Setting the set and parameters.</p> <p>Indicates the active unit of measurement for the displayed temperature.</p> <p>Indicates the active hot cycle.</p> <p>Indicates the active cold cycle.</p> <p>Indicates the active defrost cycle.</p> <p>Indicates the active External power supply mode.</p> <p>Indicates alarm is present.</p> <p>Indicates the active road mode.</p> <p>Indicates the active condenser fan.</p> <p>Indicates the active evaporator fan.</p> <p>Display of cold room temperature.</p> <p>Alarm display.</p> |
|--|--|

4.1.2 On/Off unit

- Check that the LED (1, Figure 8) of the in-cab controller is on.
- To turn on the unit, press and hold the power button  (2) for 3 seconds.

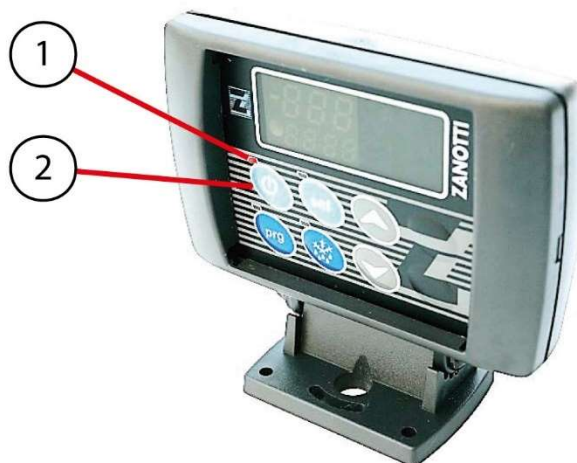







Figure 8 - On button

The display will show icons representing the various components that are active during the various operational phases:

- Cooling:   

- Heating:   

- Defrosting: 



- Press the power button  to turn off the refrigerator unit, or in Road mode, turn off the ignition key directly to switch off the vehicle. This way, the next time the vehicle is switched on, the unit will automatically restart without having to press the power button.

Figure 9 - On/off Button A

Road mode Operation

When the vehicle engine is turned on through the ignition key, automatically activates the mode of operation of the Road mode, indicated by the LED Road mode indicator .

External power supply mode Operation





	<p>CAUTION</p> <p>Make sure the supply voltage is as stated on the label (the tolerance is +/-10% for the nominal voltage)</p>
---	---

By connecting the plug to the mains, the External power supply operating mode is automatically enabled, identified by the LED External power supply mode .

	<p>CAUTION</p> <p>Before starting the motor make sure that you have disconnected the External power supply plug.</p>
---	---

4.1.3 Setting the work point

To set the work point, proceed as follows:

- Press the set button . The actual flashing value appears in the red display, while the abbreviation **Set** appears in the yellow display.
- Press the up  and down buttons  to set the desired value.
- Press the set button again  and wait 10 seconds to store the new value.

4.1.4 Manual Defrost

This unit main control unit is responsible for managing the defrosting cycles, as indicated in paragraph 3.2.3.

However, it is possible to begin manual defrosting by pressing the defrosting button .

During this phase the defrost LED lights up .



NOTE

Defrosting ends after a maximum period of time or when a thermostat positioned on the evaporator's fins initiates the process.



NOTE

The start of manual defrosting resets the time count relative to the beginning of the next programmed defrosting.

4.2 Alarms and warnings

There is an acoustic alarm accompanying each warning signal, in addition to the lighting of the alarm LED  and the corresponding alarm symbol on the alarm display (16, Figure 7).

Pressing any key will interrupt the acoustic warning.





Normally, the alarm is displayed until it is active. In the event of an automatic alarm reset, the alarm disappears, but it remains in the memory and can be reviewed in the alarm archive.

4.2.1 Alarm archive

The control unit is capable of storing the last 10 alarms that have occurred as well as their duration.

When an alarm occurs in the archive, the alarm LED  will blink.

To view the stored alarms, proceed as follows:

- Press and hold the up button for a few seconds 
- A display on top shows the code of the last alarm, while a display at the bottom indicates the number of interventions that have been made
- Pressing the up button again  displays the codes of the other alarms, from the most recent to the oldest.
- To view the duration of the alarm, press the set button 
- Pressing the up button  or the set button again will trigger the  next alarm.



NOTE

A **noA** abbreviation will appear on the display if there are no alarms in the archive.

4.2.2 Alarm cancellation

To clear the alarms, proceed as follows:

- Enter alarm display (see 4.2.1)
- To cancel the displayed alarm, press the set button for 2 seconds  until the abbreviation **rSt** appears on the lower display.









NOTE

Active alarms cannot be erased.





- To delete the entire archive press the set button for 10 seconds 
- The display will show **rSt, clr, noA**, in sequence.

4.2.3 List of alarms and warnings

Abbreviation	Alarm	Description	Possible causes	Possible solutions
PrL PMI	Low pressure	<p>After the intervention of the low pressure switch, the unit stops.</p> <p>The alarm led is activated on the display  and the abbreviation PrL (PrL) appears.</p> <p>When the correct pressure value re-establishes, the unit restarts automatically.</p> <p>In the case of a frequent number of interventions during a given period, the PMI (PMI) alarm appears, which stops the unit permanently.</p>	<p>Loss of coolant</p> <p>Evaporator packed with ice</p> <p>Evaporator fan(s) not working</p> <p>Very low external temperature (<0°C)</p> <p>Wet inside the circuit</p>	<p>Defrost manually and ensure that the evaporative pack is clean and free of obstructions.</p> <p>Make sure the evaporator fans are working properly.</p> <p>Change the Dry filter</p>
PrH PMS	High pressure	<p>In response to the high-pressure pressure switch, the unit stops.</p> <p>The alarm LED is activated on the display  and the abbreviation Prh (Prh) appears.</p> <p>When the correct pressure value re-establishes, the unit restarts automatically.</p> <p>When there are numerous interventions within a given period, the PMS (PMS) alarm is displayed, which causes the unit to be permanently stopped.</p>	<p>Condenser fan not working</p> <p>Dirty condenser or insufficient air flow</p> <p>Moisture inside the circuit</p>	<p>Clean the condenser.</p> <p>Check the correct operation of the condenser fan.</p> <p>Ensure that nothing is blocking the air flow in front of the condenser.</p> <p>Check the filter.</p>







Abbreviation	Alarm	Description	Possible causes	Possible solutions
F1t FtB	Electric motor guard (External power supply mode operation only)	<p>After the intervention of the thermal relay protecting the electric motor, the unit stops.</p> <p>The alarm LED is activated on the display  and the abbreviation F1t (F1t) appears.</p> <p>After a certain time, the unit restarts automatically.</p> <p>When a high number of interventions occurs in a given period, the ftb (Ftb) alarm is displayed, thereby permanently stopping the unit.</p>	<p>Electric motor not work properly.</p> <p>Low power supply voltage</p> <p>Excessive distance from the power supply</p> <p>Incorrect CPR (KVL) valve adjustment</p>	<p>Make sure the mains voltage is correct.</p> <p>Check that there are short circuits inside the electric motor.</p> <p>Check the calibration of the thermal relay.</p>
E01	Probe failure	<p>The code E01 (E01) appears on the display and the alarm LED is activated .</p> <p>The unit stops.</p>	<p>Temperature probe faulty or not properly connected</p>	<p>Check the probe connection.</p>
PAB Ab	Battery voltage	<p>The abbreviation PAB (PAB) indicates a decrease in the power supply voltage. If the decrease is excessive, the display shows the abbreviation Ab (Ab) and the unit stops.</p> <p>When the voltage returns to the optimum preset value, the unit restarts automatically.</p>	<p>The alternator is not loading</p> <p>Battery not performing well</p> <p>Absorption of total electrical current is excessive</p>	<p>Make sure that the battery is charged</p> <p>Check the efficiency of the vehicle's electrical system</p> <p>Check the subkey connection</p>
ALM	Dual Power Supply (External power supply mode option unit only)	<p>This alarm is generated when the External power supply mode and road mode signal are present simultaneously.</p> <p>This alarm stops the refrigeration unit. The display shows the ALM (ALM) symbol and the External power supply mode  and road mode  icons flash simultaneously.</p>	<p>Turn the power key when the plug is still attached</p> <p>The plug can be connected when the vehicle is still on.</p>	<p>Turn off the vehicle.</p> <p>Disconnect the plug before turning the power key.</p>

Abbreviation	Alarm	Description	Possible causes	Possible solutions
SEE SEr	Maintenance	<p>Upon reaching a set number of operating hours, the SEE (SEE) <u>External power supply mode maintenance</u> or SEr (SEr) <u>road mode maintenance</u> are generated, alternating with the temperature display. The display can be temporarily reset by pressing any key. It will appear again after the refrigeration unit has been switched off and then on.</p> <p>Once scheduled maintenance has been completed, it will be the responsibility of the authorised technical assistance centre to reset the maintenance signs and set the subsequent ones.</p>		
noL	Keyboard communication failure	This abbreviation is displayed when there is no communication between the keyboard and the card. If no operation can be performed via the keyboard, the unit must be turned off by using the ignition key of the vehicle or by removing the power supply plug.	Connection cable between card and keyboard defective or not connected properly	Check the cable and connector on the keyboard.

Abbreviation	Alarm	Description	Possible causes	Possible solutions
<p>Pof</p> <p>Pon</p>	<p>Keyboard Lock/Unlock</p>	<p>The abbreviation PoF (PoF) indicates that the keyboard lock is active (by pressing the up  and down  buttons simultaneously for at least 5 seconds).</p> <p>The following report is displayed for three seconds every time the keyboard is locked and you attempt to:</p> <ul style="list-style-type: none"> - edit the setting - enter programming - turn off the card <p>To disable the keyboard lock, press the up  and down  buttons again simultaneously for at least 5 seconds, until the Pon (Pon) symbol appears on the display.</p>		
<p>rSt</p>	<p>Reset</p>	<p>This warning is displayed for 3 seconds the first time a button is pressed with an alarm in progress.</p>		

4.3 Changing the operating parameters

To change the operating parameters, proceed as follows:

- press the prg button  for a few seconds to display the first available parameter
- press the up  and down  buttons to scroll the parameters
- press the button  to change the parameter
- press the up  and down  buttons to set the desired value
- press the button  again to confirm the value

5 MAINTENANCE

As indicated in paragraph 4.2.3, upon reaching a set number of operating hours, **SEE (SEE) External power supply mode maintenance** or **Ser (SEr) road mode maintenance** are generated, alternating with the temperature display.



CAUTION

Prior to any intervention, ensure that the in-cab controller is turned OFF and that the unit cannot start up during service.

In addition to the maintenance described, it is recommended to replace the engine oil at least once a year, even if the engine has not carried out the expected number of operating hours.



NOTE

The maintenance intervals shown in this manual are indicative and may vary. For scheduled maintenance, follow the alarm warnings.

5.1 ROAD MODE Service Program (SEr warning)

Working hours	100	800	1600	2400	3200	4000	4800	5600
First check	X							
Maintenance A		X	X	X	X	X	X	X
Maintenance B			X		X		X	

5.2 EXTERNAL POWER SUPPLY MODE Service Program (SEe Report)

Working hours	1000	2000	3000	4000	5000	6000	7000
Maintenance E	X	X	X	X			

5.3 List of interventions



FIRST CHECK	<ul style="list-style-type: none"> • Check the tension of the compressor belt • Ensure that the low speed engine is not vibrating and that the compressor is securely fastened • Check the tightness of the bolts and screws on the unit as well as on the compressor kit
MAINTENANCE A	<ul style="list-style-type: none"> • Clean the condenser and the evaporator • Check the oil level in the compressor • Check the operation of the defrosting and the effectiveness of the condensate water drain • Clean the battery and its terminals • Carry out checks on the coolant charge • Perform checks on the functions of the in-cab controller Check and clean the electrical connections • Check the tightening torque of the bolts on the compressor kit • Replace the transmission belts
MAINTENANCE B	<ul style="list-style-type: none"> • Replace and clean the brushes of direct current electric motors • Check the bearings of the belt tensioners and the bearings of the mechanical units. • Check the operation of the evaporator and condenser fans
MAINTENANCE E	<ul style="list-style-type: none"> • Check voltages and currents at the ends of the following components: <ul style="list-style-type: none"> ○ transformer ○ diode bridge ○ AC motor • Clean and check the efficiency of the various electrical connections • Check the intervention value of the F1T thermal relay
Every 6 months	<ul style="list-style-type: none"> • Carefully clean the condenser (*)
Every year	<ul style="list-style-type: none"> • Filter drier replacement. • Clean and inspect the thermostatic expansion valve opening
Every two years	<ul style="list-style-type: none"> • Replace the oil in the compressor (carefully use only polyester POE oil) • Replace the coolant gas • Replace the thermostatic expansion valve opening

(*) In order to ensure continuous unit performance, it is recommended to clean the condenser at least once every six months. The operation can be carried out by compressed air (directed from the inside out), using a soft bristle brush and taking care not to damage the fins. If the condenser contains residues that cannot be removed by the procedures described above (e.g. soil, salts, mushrooms, moulds, etc.), it may be necessary to clean it. A suitable product is the Unison's DEK 34 Alluter or other equivalent. Always use them according to the manufacturer's specifications.

6 APPENDIX

6.1 Basic Troubleshooting

Following are some common issues and some easy-to-implement recommendations as well as controls:

Issue	Cause	Check
<p>The unit does not turn on when the power button is pressed , even when the ignition key of the vehicle is turned on or the unit is connected to the power supply</p>	<ul style="list-style-type: none"> • The battery is low • The battery is disconnected • The battery fuse has blown • The alternator does not load • The cable of the subkey is disconnected • The power supply cable is faulty • The fuses 5A on the board have blown 	<p>Check that the LED (presence of voltage) above the start key  is lit. Check the battery fuse BF.</p>
<p>The unit runs during Road mode operation, but the temperature does not decrease and no alarm is displayed.</p>	<ul style="list-style-type: none"> • The road compressor is not activated 	

6.2 Removal and mounting of the flaps of the condenser unit



CAUTION

DO NOT remove the side frame from the front, as shown in Figure 10, to avoid damaging the unit.

Follow the procedure below to remove the flap.



Figure 10 - Wrong removal of the side frame.

6.2.1 Removal

To remove the side frames of the condenser unit, proceed as follows:

- Unscrew the screws (A, Figure 11) with the appropriate tool



Figure 11 - Fastening screws on the side of the machine

- Slide the side to the front wall for at least 3 cm [1.18 in].



Figure 12 - Sliding the side frame

- Remove the side frame.



Figure 13 - Removing the side frame

6.2.2 Assembly

Following the removal procedure in reverse order, reassemble the side frame, making sure that the lower part of the side frame is correctly inserted in its guide (B, Figure 14).



Figure 14 - Mounting the side frame

6.3 Fuses



CAUTION

Before opening the electrical panel, check that the unit is not live.



NOTE

Most fuses are located inside the electrical panel and on the electronic board.

The battery fuse is connected directly to the positive cable during installation.

The number of fuses varies depending on the model and the options that are envisaged for the unit.









Remove the left panel to gain access to the fuses on the electrical panel.



CAUTION

Refer to the procedure in paragraph 6.2 in order to remove the side frame.

6.3.1 Fuse List

Abbreviation	Type	Description	Location	220/1/50-60	400/3/50	115/1/60	12V	24V
FS		Transformer main fuse	Electrical panel	6A	4A (x2)	10A	-	-
FGR		Transformer secondary fuse	Electrical panel	-	-	-	40A	30A
FGS		Transformer secondary fuse	Battery	-	-	-	40A	40A
FB		External power supply mode CPU guard fuse	MP Card	-	-	-	5A	5A
FR		Road mode CPU guard fuse	MP Card	-	-	-	5A	5A
FFR		Stand-by compressor guard fuse	MP Card	-	-	-	10A	10A
FFS		Road compressor guard fuse	MP Card	-	-	-	10A	10A
FSS		Defrost solenoid valve guard fuse	MP Card	-	-	-	10A	10A
F6-F6/1		Condenser fan guard fuses	MP Card	-	-	-	30A	20A
F8-9-10-11		Evaporator fan guard fuses	MP Card	-	-	-	20A	15A

Maintenance Intervention Card _____ hours

Date	Model	S/N	Operating Hours (Road mode)	Operating Hours (External power supply mode)
------	-------	-----	--------------------------------	--

Alarms Log

Parts replaced

Notes

Maintenance Intervention Card _____ hours

Date	Model	S/N	Operating Hours (Road mode)	Operating Hours (External power supply mode)

Alarms Log

Parts replaced

Notes

Maintenance Intervention Card _____ hours

Date	Model	S/N	Operating Hours (Road mode)	Operating Hours (External power supply mode)
------	-------	-----	--------------------------------	--

Alarms Log

Parts replaced

Notes

Maintenance Intervention Card _____ hours

Date	Model	S/N	Operating Hours (Road mode)	Operating Hours (External power supply mode)
------	-------	-----	--------------------------------	--

Alarms Log

Parts replaced

Notes

Maintenance Intervention Card _____ hours

Date	Model	S/N	Operating Hours (Road mode)	Operating Hours (External power supply mode)
------	-------	-----	--------------------------------	--

Alarms Log

Parts replaced

Notes

Maintenance Intervention Card _____ hours

Date	Model	S/N	Operating Hours (Road mode)	Operating Hours (External power supply mode)
------	-------	-----	--------------------------------	--

Alarms Log

Parts replaced

Notes

Maintenance Intervention Card _____ hours

Date	Model	S/N	Operating Hours (Road mode)	Operating Hours (External power supply mode)
------	-------	-----	--------------------------------	--

Alarms Log

Parts replaced

Notes

Maintenance Intervention Card _____ hours

Date	Model	S/N	Operating Hours (Road mode)	Operating Hours (External power supply mode)

Alarms Log

Parts replaced

Notes

Maintenance Intervention Card _____ hours

Date	Model	S/N	Operating Hours (Road mode)	Operating Hours (External power supply mode)
------	-------	-----	--------------------------------	--

Alarms Log

Parts replaced

Notes

Maintenance Intervention Card _____ hours

Date	Model	S/N	Operating Hours (Road mode)	Operating Hours (External power supply mode)
------	-------	-----	--------------------------------	--

Alarms Log

Parts replaced

Notes

Maintenance Intervention Card _____ hours

Date	Model	S/N	Operating Hours (Road mode)	Operating Hours (External power supply mode)
------	-------	-----	--------------------------------	--

Alarms Log

Parts replaced

Notes

Maintenance Intervention Card _____ hours

Date	Model	S/N	Operating Hours (Road mode)	Operating Hours (External power supply mode)

Alarms Log

Parts replaced

Notes

Maintenance Intervention Card _____ hours

Date	Model	S/N	Operating Hours (Road mode)	Operating Hours (External power supply mode)
------	-------	-----	--------------------------------	--

Alarms Log

Parts replaced

Notes



Zanotti S.p.A.
M. L. King, 30
46020 Pegognaga (MN) Italy
Tax Code/VAT No. 0185670203
T. +39 0376 5551
F. +39 0376 536554
info@zanotti.com

www.zanotti.com