

**DAIKIN**



# INSTALLATION MANUAL

## ***VRV IV*** System air conditioner

---

READ THESE INSTRUCTIONS CAREFULLY BEFORE INSTALLATION.  
KEEP THIS MANUAL IN A HANDY PLACE FOR FUTURE REFERENCE.

---

**BS unit**

**BS1Q10A7V1B**  
**BS1Q16A7V1B**  
**BS1Q25A7V1B**

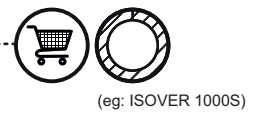
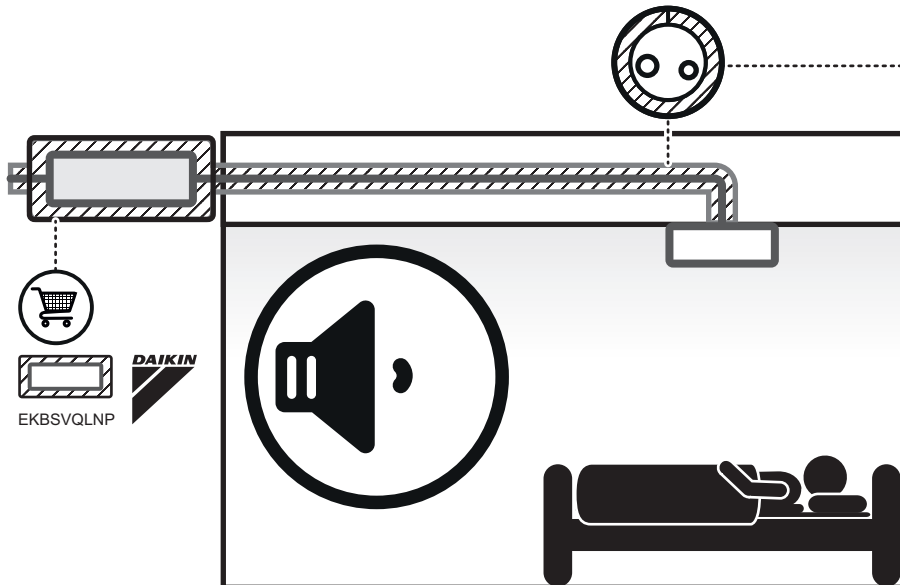
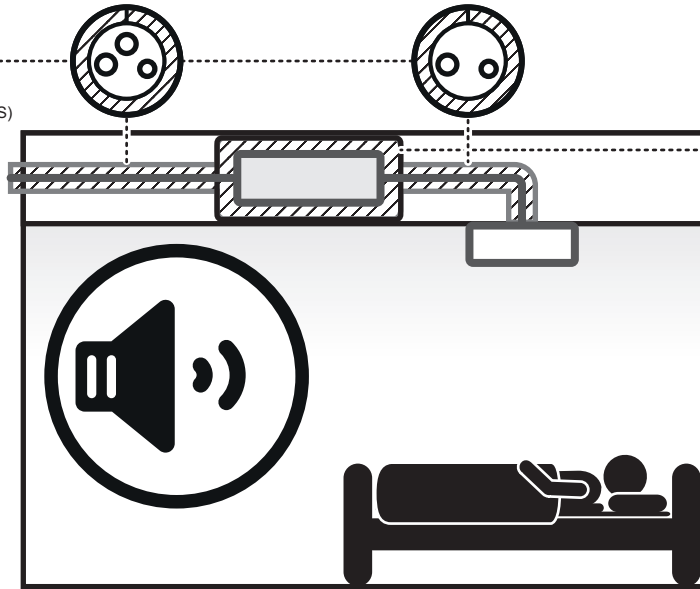
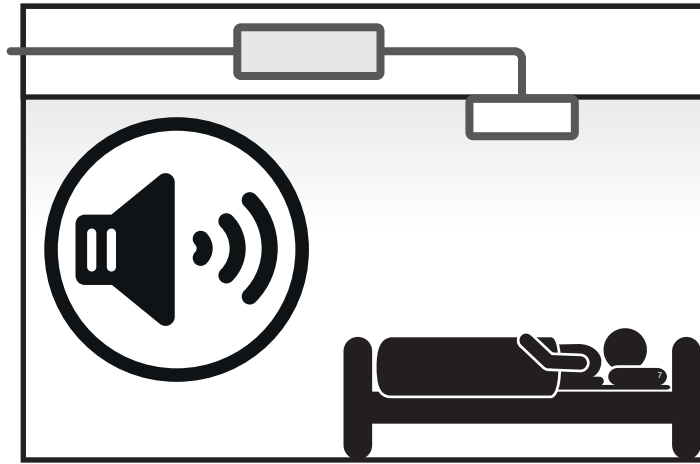

CE - DECLARATION-OF-CONFORMITY  
CE - KONFORMITÄTSSERKLÄRUNG  
CE - DECLARATION-DE-CONFORMITE  
CE - CONFORMITEITS/VERKLARING

**Daikin Europe N.V.**

CE - DECLARACION-DE-CONFORMIDAD  
CE - DICHIARAZIONE-DE-CONFORMITA  
CE - ΔΗΛΩΣΗ ΣΥΜΜΟΡΦΩΣΗΣ

CE - DECLARACIÓN-DE-CONFORMIDAD  
CE - ЗАЯВЛЕНИЕ-О-СОТВЕТСТВИИ  
CE - OPEYDELSERKLARING  
CE - FÖRSÄKRAN-OM-ÖVERENSSTÄMMELSE

CE - IZJAVA O-USKLABENOSTI  
CE - ILMOUTUS-YHDENMUKAISUUDESTA  
CE - DEKLARACJA-ZGODNOSCI  
CE - DECLARAȚIE-DE-CONFORMITATE

CE - IZJAVA O SKLADNOSTI  
CE - VASTAVUSDEKLARAATIOON  
CE - DEKLARACIJA-ZA-CŔBTVETSTVIE  
CE - UYGUNLUK-BEYANI

CE - ATTIKITES-DEKLARACIJA  
CE - ATBLISTIBAS-DEKLARACIJA  
CE - VYHLAŠENIE-ZHODY  
CE - UYGUNLUK-BEYANI

01 02 03 04 05 06 07 08 09 10 11 12 13 14 15 16 17 18 19 20 21 22 23 24 25

- 01 are in conformity with the following standard(s) or other normative document(s), provided that these are used in accordance with our instructions;
- 02 der/den folgenden Norm(en) oder einem anderen Normdokument oder dokumenten entsprechend/einstimmend;
- 03 si je genalib useren Anweisungen eingesetzt werden;
- 04 conformes à laux normes(s) ou autre(s) document(s) normatifs), pour autant qu'ils soient utilisés conformément à nos instructions;
- 05 conform de volgerde norm(en) of één of meer andere bindende documenten zijn, op voorwaarde dat ze worden gebruikt overeenkomstig onze instructies;
- 06 están en conformidad con las(s) siguiente(s) norma(s) u otro(s) documento(s) normativo(s), siempre que sean utilizados de acuerdo con nuestras instrucciones;
- 07 sono conformi alle(s) seguente(s) standardi (o) altri(i) documento(i) normativi), a patto che vengano usati in conformità alle nostre istruzioni;
- 08 είναι σύμφωνα με τις οδηγίες μας;
- 09 в соответствии с положениями;
- 10 under kapitajisele at bestemmelserne i;
- 11 enligt villkoren i;
- 12 gemäß den Vorschriften der;
- 13 conformément aux stipulations des;
- 14 overeenkomstig de bepalingen van;
- 15 siguiendo las disposiciones de;
- 16 secondo le prescrizioni per;
- 17 по предписаниям;
- 18 zgodnie z postanowieniami Dyrektyw;
- 19 в орна превиделор;
- 20 vanligt för de bestämmelserna i;
- 21 enligt villkoren i;
- 22 med de tekniska kraven i;
- 23 iakttagande av bestämmelserna i;
- 24 överensstämmande med de bestämmelserna i;
- 25 energiai probasbas, kas notifikas;
- 26 prema odredbama;
- 27 kveitai aiži;
- 28 zgodnie z postanowieniami Dyrektyw;
- 29 в орна превиделор;

**BS1Q10A7V1B\*, BS1Q16A7V1B\*, BS1Q25A7V1B\*,**  
\* = . 1, 2, 3, ... 9

- 01 are in conformity with the following standard(s) or other normative document(s), provided that these are used in accordance with our instructions;
- 02 der/den folgenden Norm(en) oder einem anderen Normdokument oder dokumenten entsprechend/einstimmend;
- 03 si je genalib useren Anweisungen eingesetzt werden;
- 04 conformes à laux normes(s) ou autre(s) document(s) normatifs), pour autant qu'ils soient utilisés conformément à nos instructions;
- 05 conform de volgerde norm(en) of één of meer andere bindende documenten zijn, op voorwaarde dat ze worden gebruikt overeenkomstig onze instructies;
- 06 están en conformidad con las(s) siguiente(s) norma(s) u otro(s) documento(s) normativo(s), siempre que sean utilizados de acuerdo con nuestras instrucciones;
- 07 sono conformi alle(s) seguente(s) standardi (o) altri(i) documento(i) normativi), a patto che vengano usati in conformità alle nostre istruzioni;
- 08 είναι σύμφωνα με τις οδηγίες μας;
- 09 в соответствии с положениями;
- 10 under kapitajisele at bestemmelserne i;
- 11 enligt villkoren i;
- 12 gemäß den Vorschriften der;
- 13 conformément aux stipulations des;
- 14 overeenkomstig de bepalingen van;
- 15 siguiendo las disposiciones de;
- 16 secondo le prescrizioni per;
- 17 по предписаниям;
- 18 zgodnie z postanowieniami Dyrektyw;
- 19 в орна превиделор;

- 01 Note \* as set out in <b> and judged positively by <b> according to the Certificate <b>.
- 02 Hinweis \* wie in der <b> aufgeführt und von <b> positiv beurteilt gemäß Zertifikat <b>.
- 03 Remarque \* tel que défini dans <b> et évalué positivement par <b> conformément au Certificat <b>.
- 04 Bemerk \* zoals vermeld in <b> en positief beoordeeld door <b> overeenkomstig Certificaat <b>.
- 05 Nota \* como se establece en <b> y es valorado positivamente por <b> de acuerdo con el Certificado <b>.



Jean-Pierre Beuselink  
Director  
Ostend, 5th of May 2014

3PW40917-4E

- 09 02 03 04 05 06 07 08 09 10 11 12 13 14 15 16 17 18 19 20 21 22 23 24 25
- 09 02 03 04 05 06 07 08 09 10 11 12 13 14 15 16 17 18 19 20 21 22 23 24 25
- 11 02 03 04 05 06 07 08 09 10 11 12 13 14 15 16 17 18 19 20 21 22 23 24 25
- 12 03 04 05 06 07 08 09 10 11 12 13 14 15 16 17 18 19 20 21 22 23 24 25
- 13 04 05 06 07 08 09 10 11 12 13 14 15 16 17 18 19 20 21 22 23 24 25
- 14 05 06 07 08 09 10 11 12 13 14 15 16 17 18 19 20 21 22 23 24 25
- 15 06 07 08 09 10 11 12 13 14 15 16 17 18 19 20 21 22 23 24 25
- 16 07 08 09 10 11 12 13 14 15 16 17 18 19 20 21 22 23 24 25

- 17 02 03 04 05 06 07 08 09 10 11 12 13 14 15 16 17 18 19 20 21 22 23 24 25
- 18 03 04 05 06 07 08 09 10 11 12 13 14 15 16 17 18 19 20 21 22 23 24 25
- 19 04 05 06 07 08 09 10 11 12 13 14 15 16 17 18 19 20 21 22 23 24 25
- 20 05 06 07 08 09 10 11 12 13 14 15 16 17 18 19 20 21 22 23 24 25
- 21 06 07 08 09 10 11 12 13 14 15 16 17 18 19 20 21 22 23 24 25
- 22 07 08 09 10 11 12 13 14 15 16 17 18 19 20 21 22 23 24 25
- 23 08 09 10 11 12 13 14 15 16 17 18 19 20 21 22 23 24 25
- 24 09 10 11 12 13 14 15 16 17 18 19 20 21 22 23 24 25
- 25 10 11 12 13 14 15 16 17 18 19 20 21 22 23 24 25

- 08 estão em conformidade com a(s) seguinte(s) norma(s) ou outro(s) documento(s) normativo(s), desde que estes sejam utilizados de acordo com as nossas instruções;
- 09 соответствуют следующим стандартам или другим нормативным документам, при условии их использования согласно нашим инструкциям;
- 10 ovenholder følgende standard(er) eller andre andre retningsgivende dokument(er), brodsat at disse anvendes i henhold til vore instruks;
- 11 respektive utrustning är utförd i överensstämmelse med och följer följande standard(er) eller andra normgivande dokument, under förutsättning att användning sker i överensstämmelse med våra instruktioner;
- 12 respektive utstyr er i overensstemmelse med følgende standard(er) eller andre normgivende dokument(er), under forudsætning af at disse bruges i henhold til våre instruksjoner;
- 13 rastaraat seuraavien standardien ja muiden ohjeellisten dokumenttien vastainmukaista edellyttäen, että niitä käytetään ohjeidemme mukaisesti;
- 14 za predložku, že sou využívají v souladu s našimi pokyny, odpovídají následujícím normám nebo normativním dokumentům;
- 15 u skladu sa slijedećim standardom(i) ili drugim normativnim dokumentom(i)ma, uz uvjet da se oni koriste u skladu s našim uputama;

**Low Voltage 2006/95/EC  
Electromagnetic Compatibility 2004/108/EC \***

- 01 Direktiven, med senere ændringer.
- 11 Direktiv, med senere ændringer.
- 12 Direktiv, med forældre ændringer.
- 13 Direktive, se također izmjenama.
- 14 pletenim znění.
- 15 Smjernice, kako je izmijenio.
- 16 irányelvek és módosítások rendelkezéseit.
- 17 változások és módosítások irányelvei.
- 18 Direktivelor, med senere ændringer.
- 19 Direktive, med senere ændringer.
- 20 Direktive, med forældre ændringer.
- 21 Direktive, se također izmjenama.
- 22 Direktive su popravljajmas.
- 23 Direktivus un to papildinajmus.
- 24 Snemice, v platnom znien.
- 25 Degistirimş haleteryle Yönetmeliker.

- 02 Direktiven, med senere ændringer.
- 11 Direktiv, med senere ændringer.
- 12 Direktiv, med forældre ændringer.
- 13 Direktive, se također izmjenama.
- 14 pletenim znění.
- 15 Smjernice, kako je izmijenio.
- 16 irányelvek és módosítások rendelkezéseit.
- 17 változások és módosítások irányelvei.
- 18 Direktivelor, med senere ændringer.
- 19 Direktive, med senere ændringer.
- 20 Direktive, med forældre ændringer.
- 21 Direktive, se također izmjenama.
- 22 Direktive su popravljajmas.
- 23 Direktivus un to papildinajmus.
- 24 Snemice, v platnom znien.
- 25 Degistirimş haleteryle Yönetmeliker.

- 11 Information \* enigi <b> och godkants av <b> enligt Certifikat <b>.
- 12 Merk \* som del fremkommer i <b> og glemten positiv til <b> i henhold til <b>.
- 13 Huom \* jakko este stabil in <b> si arecizat pozitiv hvalajmasi/Sertifikaat <b> mukasasti.
- 14 Poznámka \* jak bylo uvedeno v <b> a pozitivně zjiřeno <b> v souladu s ověřením <b>.
- 15 Napomena \* kako je izloženo u <b> pozitivno odobrieno od strane <b> prema Certifikatu <b>.

- 21 Zabeleška \* iaktro e izloženo v <b> u ovieneno pozitivno od <b> oomaoo.
- 22 Pastaba \* kap nustatija <b> ir kaip teigiama nuspreta <b> pagal Sertifika <b>.
- 23 Pastabas \* ká norádis <b> an atibisiš <b> pozitiuagam vėrdėjumam susaiaia z Sertifika <b>.
- 24 Poznámka \* ako bolo uvedeno v <b> a pozitivne ziseno <b> v souladu s ověřením <b>.
- 25 Not \* <b> a beiritiigi gbi, ve <b> Sertifikaama gpre <b> tarandian oolmu olarak degendenditigi gbi.

- 16 megfelelnek az alábbi szabvány(ok)nak vagy egyéb irányadó dokumentum(ok)nak, ha azokat előírás szerint használják.
- 17 spehlaie vymogi nasledujících norm i jiných dokumentů normalizačních, pod podmínkou, že užívajíme z nashymi instruktajmi;
- 18 sunt in conformitate cu urmatorul (urmatorele) standard(e) sau alte (documente) normative), cu condiția ca acestea să fie utilizate în conformitate cu instrucțiunile noastre
- 19 skiladig nasledjigim standardi in drugim normativi, pod pogojem, da se uporabljajo v skladu z našimi navodili;
- 20 on vastavusse järgmisi (je standarditega) või teiste normatiivsete dokumentitega, kui need kasutatakse vastavalt meie juhendile;
- 21 соответстват на следните стандарти или други нормативни документи, при условие, че се използват съгласно нашите инструкции;
- 22 atitinka zemiau nurodytus standartus ir (arba) kitus norminius dokumentus su sąlyga, kad yra naudojami pagal mūsų nurodymus;
- 23 idaj, ja leliti atitilisi razloža norudjumeu, abisi se kojiseton standardien o citem normativem dokumentem;
- 24 u skladu sa slijedećim standardom(i) ili drugim normativnim dokumentom(i)ma, uz uvjet da se oni koriste u skladu s našim uputama;
- 25 inünin, laikmalirmsa gpre kulaimimsa kopsulajva esąjidiigi standartiar ve norm beiften beigelerte uyimulidur;



**DAIKIN EUROPE N.V.**

Zandvoordestraat 300, B-8400 Oostende, Belgium

## CONTENTS

1. SAFETY PRECAUTIONS .....	1
2. BEFORE INSTALLATION .....	4
3. SELECTING INSTALLATION SITE .....	5
4. PREPARATIONS BEFORE INSTALLATION .....	6
5. BS UNIT INSTALLATION .....	7
6. REFRIGERANT PIPING WORK .....	8
7. ELECTRIC WIRING WORK .....	13
8. INITIAL SETTING .....	16
9. TEST OPERATION .....	16
10. WIRING PARTS TABLE .....	17

## 1. SAFETY PRECAUTIONS

Please read these “SAFETY PRECAUTIONS” carefully before installing air conditioning unit and be sure to install it correctly. After completing installation, conduct a trial operation to check for faults and explain to the customer how to operate the air conditioner and take care of it with the aid of the operation manual. Ask the customer to store the installation manual along with the operation manual for future reference.

**This air conditioner comes under the term “appliances not accessible to the general public”.**

VRV System is a class A product. In a domestic environment this product may cause radio interference in which case the user may be required to take adequate measures.

The original instructions are written in English. All other languages are translations of the original instructions.

Meaning of WARNING and CAUTION notices

 **WARNING** ..... Failure to follow these instructions properly may result in personal injury or loss of life.

 **CAUTION** ..... Failure to observe these instructions properly may result in property damage or personal injury, which may be serious depending on the circumstances.

—  **WARNING** —————

- Ask your dealer or qualified personnel to carry out installation work.  
Do not attempt to install the air conditioner yourself. Improper installation may result in water leakage, electric shocks or fire.
- Install the air conditioner in accordance with the instructions in this installation manual.  
Improper installation may result in water leakage, electric shocks or fire.
- When installing the unit in a small room, take measures against to keep refrigerant concentration from exceeding allowable safety limits in the event of refrigerant leakage.  
Contact the place of purchase for more information. Excessive refrigerant in a closed ambient can lead to oxygen deficiency.
- Be sure to use only the specified accessories and parts for installation work.  
Failure to use the specified parts may result in the unit falling, water leakage, electric shocks or fire.

- Install the air conditioner on a foundation strong enough to withstand the weight of the unit. A foundation of insufficient strength may result in the equipment falling and causing injury.
  - Carry out the specified installation work after taking into account strong winds, typhoons or earthquakes.  
Failure to do so during installation work may result in the unit falling and causing accidents.
  - Make sure that a separate power supply circuit is provided for this unit and that all electrical work is carried out by qualified personnel according to local laws and regulations and this installation manual.  
An insufficient power supply capacity or improper electrical construction may lead to electric shocks or fire.
  - Be sure to earth the air conditioner.  
Do not earth the unit to a utility pipe, lightning conductor or telephone earth lead. Imperfect earthing may result in electric shocks or fire.  
A high surge current from lightning or other sources may cause damage to the air conditioner.
  - Be sure to install an earth leakage breaker.  
Failure to install an earth leakage breaker may result in electric shocks or fire.
  - Be sure to switch off the unit before touching any electrical parts.
  - Make sure that all wiring is secured, the specified wires are used, and that there is no strain on the terminal connections or wires.  
Improper connections or securing of wires may result in abnormal heat build-up or fire.
  - When wiring the power supply and connecting the wiring between the indoor and outdoor units, position the wires so that the EL. COMPO. BOX lid can be securely fastened.  
Improper positioning of the EL. COMPO. BOX lid may result in electric shocks, fire or the terminals overheating.
  - If refrigerant gas leaks during installation, ventilate the area immediately.  
Toxic gas may be produced if the refrigerant gas comes into contact with fire.
  - After completing installation, check for refrigerant gas leakage.  
Toxic gas may be produced if the refrigerant gas leaks into the room and comes into contact with a source of fire, such as a fan heater, stove or cooker.
  - Do not directly touch refrigerant that has leaked from refrigerant pipes or other areas, as there is a danger of frostbite.
- 



## CAUTION

- Install the BS units, power cord and connecting wires at least 1 meter away from televisions or radios to prevent picture interference and noise.  
(Depending on the incoming signal strength, a distance of 1 meter may not be sufficient to eliminate noise.)
- Remote controller (wireless kit) transmitting distance can be shorter than expected in rooms with electronic fluorescent lamps (inverter or rapid start types).  
Install the BS unit as far away from fluorescent lamps as possible.
- Make sure to provide for adequate measures in order to prevent that the outdoor unit be used as a shelter by small animals.  
Small animals making contact with electrical parts can cause malfunctions, smoke or fire. Please instruct the customer to keep the area around the unit clean.
- Do not install the air conditioner in the following locations:
  1. Where there is a high concentration of mineral oil spray or vapour (e.g. a kitchen).  
Plastic parts will deteriorate, parts may fall off and water leakage could result.
  2. Where corrosive gas, such as sulphurous acid gas, is produced.  
Corroding of copper pipes or soldered parts may result in refrigerant leakage.
  3. Near machinery emitting electromagnetic radiation.  
Electromagnetic radiation may disturb the operation of the control system and result in a malfunction of the unit.

4. Where flammable gas may leak, where there is carbon fibre or ignitable dust suspensions in the air, or where volatile flammables such as paint thinner or gasoline are handled.  
Operating the unit in such conditions may result in fire.
  5. Do not use in areas where the air is salty, such as along seacoasts, in factories or other areas with significant voltage fluctuations, or in automobiles and watercraft.  
Doing so could result in a malfunction.
- 



#### CAUTION

---

The refrigerant R410A requires that strict precautions be observed for keeping the system clean, dry and tightly sealed.

Clean and dry

Strict measures must be taken to keep impurities (including SUNISO oil and other mineral oils as well as moisture) out of the system.

Tightly sealed

R410A contains no chlorine, does not destroy the ozone layer and so does not reduce the earth's protection against harmful ultraviolet radiation. R410A will contribute only slightly to the greenhouse effect if released into the atmosphere. Therefore, sealing tightness is particularly important in installation.

Carefully read the chapter "**REFRIGERANT PIPING WORK**" and strictly observe the correct procedures.

---

## 2. BEFORE INSTALLATION

### 2-1 CAUTION CONCERNING NEW REFRIGERANT SERIES

- Since design pressure is 4.0 MPa or 40 bar (for R407C units: 3.3 MPa or 33 bar), the thickness of pipes must be greater than previously. Since R410A is a mixed refrigerant, the required additional refrigerant must be charged in its liquid state. (If the system is charged with refrigerant in its gaseous state, due to composition change, the system will not function normally.)

The indoor/outdoor unit is designed for R410A. See the catalogue for indoor/outdoor unit models that can be connected.

(Normal operation is not possible when connecting units that are originally designed for other refrigerants.)

### 2-2 PRECAUTIONS

- Hold the unit by the Hanging brackets (4 points) when opening the box and moving it, and do not lift it holding on to any other part especially the refrigerant piping.
- About installation of outdoor and indoor unit, refer to the installation manual provided with the outdoor and the indoor unit.
- This unit, both indoor and outdoor, is suitable for installation in a commercial and light industrial environment. If installed as a household appliance it could cause electromagnetic interference.









### 2-3 ACCESSORIES

Check the following accessories are included with your unit.







#### NOTE

- Do not throw away any of the accessories until installation is complete.

#### 〈BS1Q10 · 16〉

Name	1) Accessory pipes		1) Accessory pipes		2) Clamp		3) Insulation tube		Explanation Document
	(BS1Q10 only)		(BS1Q16 only)						
Quantity	1 pc.	1 pc.	1 pc.	2 pcs.	6 pcs.	10 pcs.	2 pcs.	3 pc.	1 copy
Shape	1)-1  φ9.5	1)-2  φ15.9	1)-1  φ12.7	1)-2  φ15.9	2)-1  (Small)	2)-2  (Large)	3)-1  (Small)	3)-2  (Large)	Installation manual

#### 〈BS1Q25〉

Name	1) Accessory pipes		2) Clamp		3) Insulation tube			Explanation Document
	1 pc.	2 pcs.	6 pcs.	10 pcs.	2 pcs.	2 pcs.	1 pc	
Quantity	1 pc.	2 pcs.	6 pcs.	10 pcs.	2 pcs.	2 pcs.	1 pc	1 copy
Shape	1)-1 	1)-2 	2)-1  (Small)	2)-2  (Large)	3)-1  (Small)	3)-2  (Medium)	3)-3  (Large)	Installation manual

## 2-4 COMBINATION

- This BS unit is only for systems for Models REYQ-T.  
It cannot be connected to systems for Models REYQ-M+REYQ-P.
- For series of applicable indoor units, refer to the catalog or other literature.
- Select the BS unit to fit the total capacity (sum of unit's capacity) and max. number of the indoor units to be connected downstream. About indoor unit's capacity, refer to the Table 2.

Table 1

Model	Total capacity of all downstream indoor units	Max. number of all downstream indoor units
BS1Q10	$A \leq 100$	6
BS1Q16	$100 < A \leq 160$	8
BS1Q25	$160 < A \leq 250$	8

Table 2

Capacity expressed as indoor unit's model No.	15	20	25	32	40	50	63	80	100	125	200	250
Indoor unit's capacity (for use in computation)	15	20	25	31.25	40	50	62.5	80	100	125	200	250

\* About indoor unit's capacity for HRV type (VKM), refer to the Engineering data book.

<Example>

In case of the BS unit witch connect two FXCQ32M and two FXSQ40M.

Total capacity =  $31.25 \times 2 + 40 \times 2 = 142.5 \rightarrow$  **Select BS1Q16**

## 2-5 CHECK ITEM

- For the following items, take special care during construction and check after installation is finished.

### Completion check items

Check items	Problems	Check
Are the BS units installed securely?	Falling, vibration, and operating noise	
Have you performed a gas leak test?	Does not cool or heat	
Is the insulation complete? (Refrigerant piping and pipe connection part)	Water leaking	
Is the voltage the same as that listed on the unit's nameplate?	Does not operate/burnt out	
Are all the wiring and piping correct?	Does not operate/burnt out	
Is the unit grounded?	Dangers during electrical leak	
Is the thickness of the power cord as specified?	Does not operate/burnt out	

### Hand-over check items

Check items	Check
Did you close the EL. COMPO. BOX lid?	
Did you hand the operating manual and warranty card to the customer?	

## 3. SELECTING INSTALLATION SITE

The equipment is not intended to be installed in spaces where it is better to avoid noise, like bedrooms. (**Refer to Fig. A**).

The equipment is not intended for use in a potentially explosive atmosphere.

Select an installation site where the following conditions are satisfied and that meets with your customer's approval.

- Where is resistible against weight of BS unit.
- Locations where the wall is not significantly tilted.
- Where sufficient clearance for maintenance and service can be ensured. (**Refer to Fig. 1**)
- Locations where an inspection hole (**Refer to Fig. 2**) can be installed to EL. COMPO. BOX side (See Note).
- Where the total piping length involving indoor unit and outdoor unit is below the allowable piping length. (See installation manual attached to outdoor unit.)



Note: The EL. COMPO. BOX mounting surface can be changed.

For information on how to change the mounting surface, refer to “5. BS UNIT INSTALLATION”.

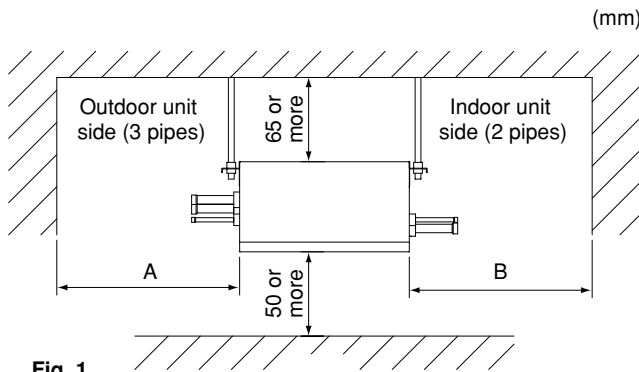

Fig. 1

BS Unit Name	A (mm)	B (mm)
BS1Q10	250 or more	250 or more (*1)
BS1Q16	250 or more (*2)	250 or more (*2)
BS1Q25	300 or more (*3)	300 or more (*3)

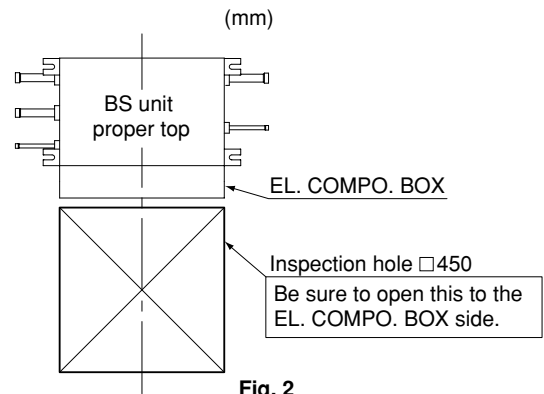

Fig. 2

- (\*1) When using accessory pipes 1)-1, 2 (Refer to 6-5 PIPING CONNECTION), provide a service space of at least 300mm.
- (\*2) When using accessory pipes 1)-1, 2 (Refer to 6-5 PIPING CONNECTION), provide a service space of at least 350mm.
- (\*3) When using accessory pipes 1)-1, 2 (Refer to 6-5 PIPING CONNECTION), provide a service space of at least 400mm.

## NOTES

- Study if the installation location is strong enough to hold the weight of the unit, and if necessary reinforce the area with a beam or other member and then install suspension bolts. Use the suspension bolts to install the unit. (Refer to “4. PREPARATIONS BEFORE INSTALLATION”)
- Install the BS unit and its power supply wiring and transmission wiring at least 1 meter away from televisions and radios to prevent image distortion and noise in those devices. Noise may still be introduced at this distance depending on the electromagnetic wave conditions.

## 4. PREPARATIONS BEFORE INSTALLATION

Refer the figure 3 and install the suspension bolts and hanging brackets.

### <Suspension bolts: For supporting the product>

- Use M8-M10 suspension bolts.
- When holes are to be made anew, used embedded inserts and embedded foundation bolts. When holes are already provided, use hole-in-anchors or the like. Install the BS unit so that its weight can be withstood.

### <Hanging bracket: For supporting the connection pipe>

- Be sure to support the connection piping around the unit using hanging brackets that are kept within 1 meter of the body side surface. Hanging excessive weight on the BS unit hanging bracket could cause the unit to fall and injure someone.

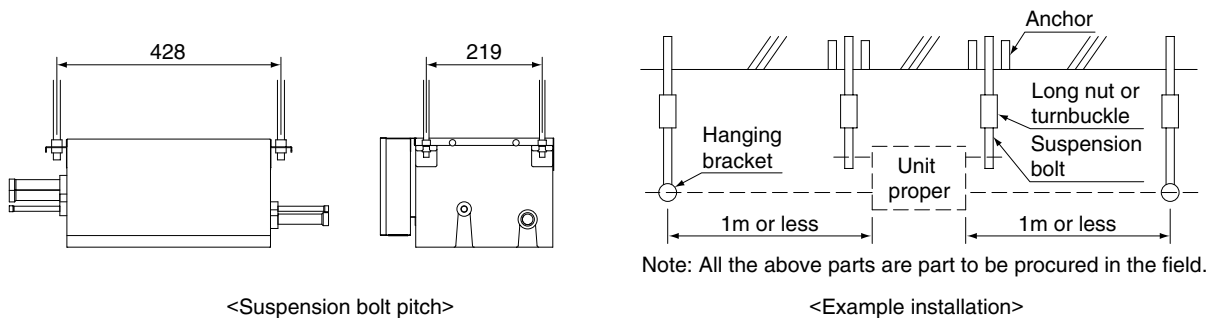

Fig. 3

## 5. BS UNIT INSTALLATION

Use only accessories and parts which are of the designated specification when installing.

(1) When necessary, use the following procedure to change the EL. COMPO. BOX mounting surface.

**(Refer to Fig. 4)**

- 1) Remove the EL. COMPO. BOX lid. (2 screws)
- 2) Remove the EL. COMPO. BOX. (2 screws)
- 3) Remove the top panel. (4 screws)
- 4) Remove the coil cover. (1 screw)
- 5) Change the pull out direction of the wire (motorized valve coil) between the body and the EL. COMPO. BOX.
- 6) Rotate the coil cover 180 degrees and attach it.
- 7) Turn the top panel around 180 degrees and attach it.
- 8) Attach the EL. COMPO. BOX.
- 9) Attach the EL. COMPO. BOX lid.

(2) Attach the hooks to the suspension bolts.

Be sure to use the nuts (M8 or M10: 3 pcs, 4 locations) and washers (For M8: Outside diameter dimension 24 to 28mm, For M10: Outside diameter 30 to 34mm: 2 pcs, 4 locations) (field supply) from both the top and bottom sides of the hanging bracket and make sure they are tightened correctly.

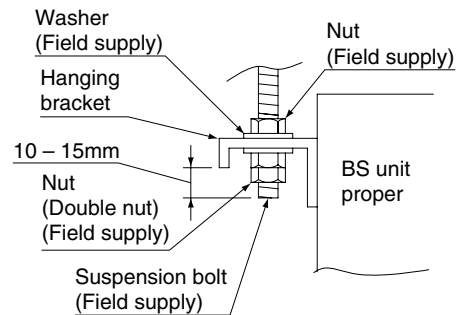

### NOTES

- The BS unit has a top and a bottom, so install it so that the diagonal lines in the figure 4 are where the top is.  
(Failing to do so may prevent the unit from operating properly and increase the volume of the operating noise.)

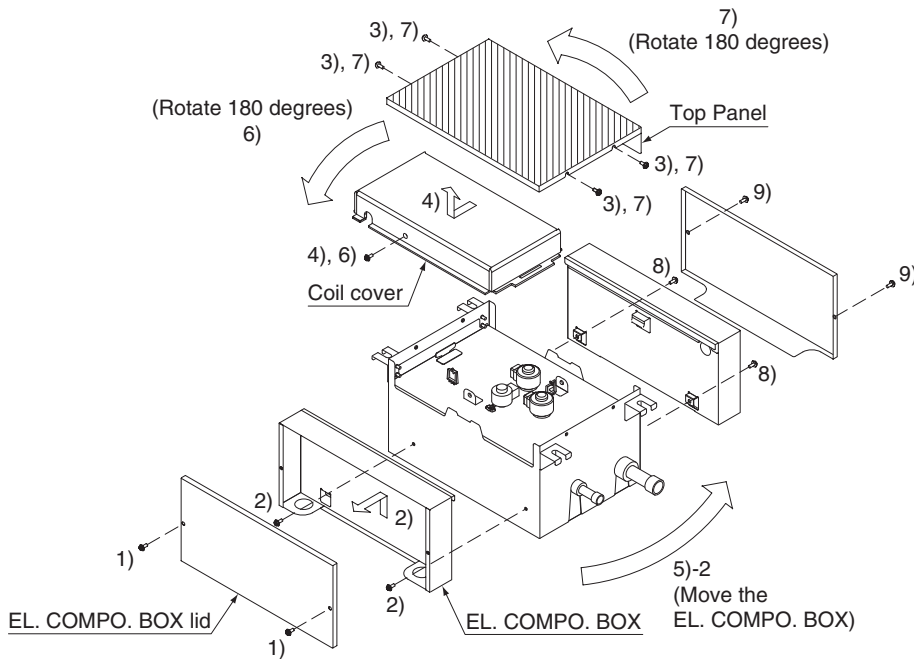
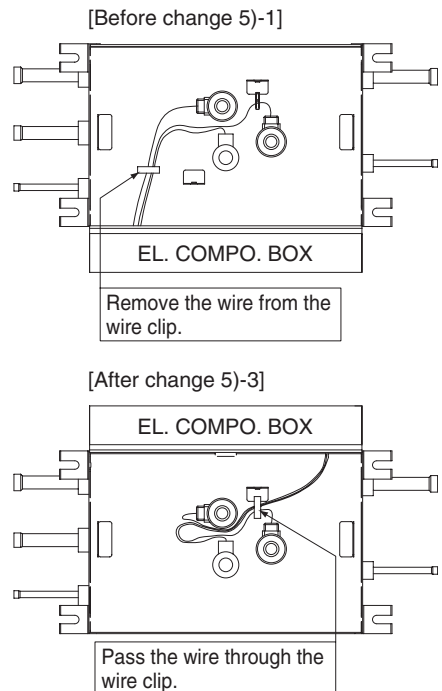

Fig. 4



## 6. REFRIGERANT PIPING WORK

- For instruction for installing piping between the outdoor unit and BS unit, selecting a refrigerant branch kit, and installing piping between the refrigerant branch kit and the indoor unit, refer to the installation manual and equipment design materials included with the outdoor unit.
- Before beginning the work, always check to make sure the type of refrigerant used is R410A. (The unit will not operate correctly with a different type of refrigerant.)
- Insulate all of the piping including the liquid pipes, HP/LP gas pipes, suction gas pipes, gas pipes, equalizer pipes (piping between outdoor units when an outdoor multi-unit system), and the pipe connections for these. Not insulating these pipes could result in water leaks or burns. In particular, suction gas flows in the HP/LP gas piping during full cooling operation, so the same amount of insulation as used for the suction gas piping is required. In addition, high-pressure gas flows in the HP/LP gas piping and gas piping, so use insulation that can withstand more than 120°C.
- Reinforce the insulation material when necessary for the installation environment. Refer to the following as a guideline.
  - For 30°C, RH75% to 80%: Thickness at least 15mm
  - For 30°C, over RH80%: Thickness at least 20mm

If not reinforced, condensation could form on the surface of the insulation. For details, refer to the Engineering data book.

### NOTES

- This product only uses the new refrigerant (R410A). Be sure to use the special pipe cutters for R410A, during installation.
- Make sure that nothing besides the specified refrigerant, such as air, gets into the refrigerant piping.
- If refrigerant gas leaks during the work, ventilate the area. (The outdoor units are filled with refrigerant.)

### 6-1 PIPING MATERIAL SELECTION

- Use only pipes which are clean inside and outside and which do not accumulate harmful sulfur, oxidants, dirt, cutting oils, moisture, or other contamination. (Foreign materials inside pipes including oils for fabrication must be 30mg/10m or less.)
- Use the following items for the refrigerant piping.

**Material:** Jointless phosphor-deoxidized copper pipe

**Size:** See “Example of connection” to determine the correct size.

**Thickness:** Select a thickness for the refrigerant piping which complies with national and local laws. For R410A, the design pressure is 4.0 MPa (40bar).

The minimum thickness and temper grade (O type, 1/2H type) of piping is shown below.

(unit: mm)

Temper grade	O type			
outer diameter	φ6.4	φ9.5	φ12.7	φ15.9
smallest thickness	0.80	0.80	0.80	0.99

(unit: mm)

Temper grade	1/2H type							
outer diameter	φ19.1	φ22.2	φ25.4	φ28.6	φ31.8	φ34.9	φ38.1	φ41.3
smallest thickness	0.80	0.80	0.88	0.99	1.10	1.21	1.32	1.43

- For information regarding the piping allowable maximum length, allowable height difference, and allowable length after a branch, refer to the installation manual that came with the outdoor unit or Engineering data book.
- The refrigerant branch kit (sold separately) is required for piping branches. For information on how to select a refrigerant branch kit, refer to the Installation Manual that came with the outdoor unit or Engineering data book.

## 6-2 PROTECTION AGAINST CONTAMINATION WHEN INSTALLING PIPES

Protect the piping to prevent moisture, dirt, dust, etc. from entering the piping.

Place	Installation period	Protection method
Outdoor	More than a month	Pinch the pipe
	Less than a month	Pinch or tape the pipe
Indoor	Regardless of the period	

### NOTE

Exercise special caution to prevent dirt or dust when passing piping through holes in walls and when passing pipe edges to the exterior.

## 6-3 PIPING CONNECTION WORK PRECAUTIONS

- When brazing refrigerant piping, begin working after replacing the nitrogen (\*1) or perform brazing while nitrogen is flowing in the refrigerant piping (\*2) (Refer to Fig. 5), and at the end made the indoor unit and BS unit flare or flange connections.

(\*1) For details on nitrogen replacement, see the “VRV Installation Manual” (available at any Daikin dealer).

(\*2) The pressure regulator for the nitrogen released when doing the brazing should be set to about 0.02 MPa (0.2kg/cm<sup>2</sup>:Enough to feel a slight breeze on your cheek).

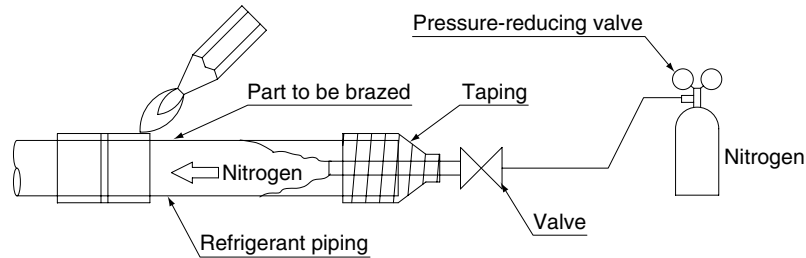

Fig. 5

### NOTES

- Do not use an anti-oxidizing agent when brazing the piping. Residual debris could clog the piping or cause parts to malfunction.
- Do not use a flux when brazing the refrigerant pipe joints. Using a chlorine flux may cause the pipes to corrode, and if it contains fluoride it may cause the refrigerant lubricant to deteriorate, adversely affecting the refrigerant piping system. Use phosphor copper brazing (BCuP-2: JIS Z 3264/B-Cu93P-710/795: ISO 3677) which does not require flux.

## 6-4 PIPING SIZE SELECTION

From **Example of connection 1** and **2** below and **Table 1, 2**, select the piping size between the outdoor unit (refrigerant branch kit) and BS unit, and between the BS unit and the indoor unit (refrigerant branch kit).

### Example of connection 1: When 1 indoor unit is connected downstream from the BS unit

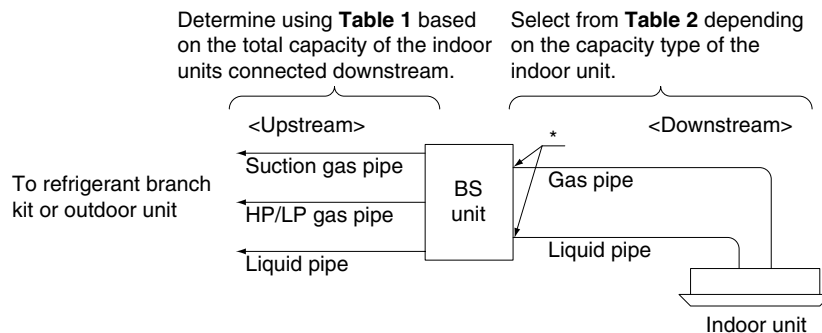

## Example of connection 2: When there is a branch downstream from the BS unit

Determine using **Table 1** based on the total capacity of the indoor units connected downstream.

For information on selecting the size of piping between the refrigerant branch kits and between a refrigerant branch kit and the indoor unit, refer to the Installation Manual that came with the outdoor unit or Engineering data book.

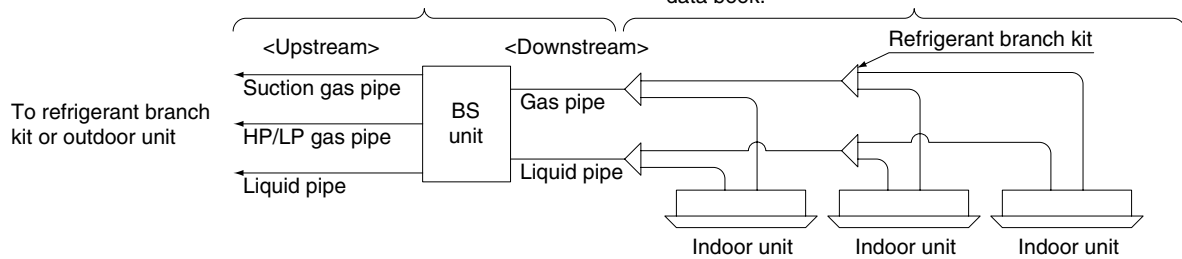

**Table 1 Indoor unit total capacity and pipe size**

Total capacity of indoor units (Q)	Piping size (outer diameter x minimum thickness)				
	Upstream			Downstream	
	Suction gas pipe	HP/LP gas pipe	Liquid pipe	Gas pipe	Liquid pipe
$Q < 150$	$\phi 15.9 \times 0.99$	$\phi 12.7 \times 0.80$	$\phi 9.5 \times 0.80$	$\phi 15.9 \times 0.99$	$\phi 9.5 \times 0.80$
$150 \leq Q < 200$	$\phi 19.1 \times 0.80$	$\phi 15.9 \times 0.99$		$\phi 19.1 \times 0.80$	
$200 \leq Q \leq 250$	$\phi 22.2 \times 0.80$	$\phi 19.1 \times 0.80$		$\phi 22.2 \times 0.80$	

**Table 2 Indoor unit connection pipe size**

Capacity type of indoor units	Piping size (outer diameter x minimum thickness)	
	Gas pipe	Liquid pipe
15, 20, 25, 32, 40, 50	$\phi 12.7 \times 0.80$	$\phi 6.4 \times 0.80$
63, 80, 100, 125	$\phi 15.9 \times 0.99$	$\phi 9.5 \times 0.80$
200	$\phi 19.1 \times 0.80$	
250	$\phi 22.2 \times 0.80$	

\* The BS unit downstream connection pipe sizes are shown below. If the pipe diameter differs from that of the indoor unit connection pipe size selected from **Table 2**, follow the instructions in “6-5 PIPING CONNECTION” and use the included pipe to make the connection.

**Table 3 BS unit connection pipe size**

BS unit	Piping size (outer diameter)	
	Gas pipe	Liquid pipe
BS1Q10	$\phi 15.9$	$\phi 9.5$
BS1Q16		
BS1Q25	$\phi 22.2$	

## 6-5 PIPING CONNECTION

Follow the connection example below and connect the site piping.

BS1Q10 type

When the downstream indoor unit total capacity is 100 or less and when one indoor unit with a capacity of 63 to 100 is connected downstream.

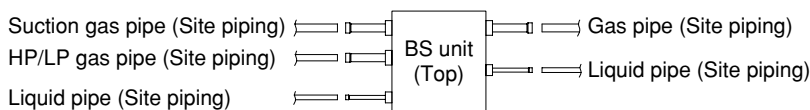

When one indoor unit with a capacity of 15 to 50 is connected downstream

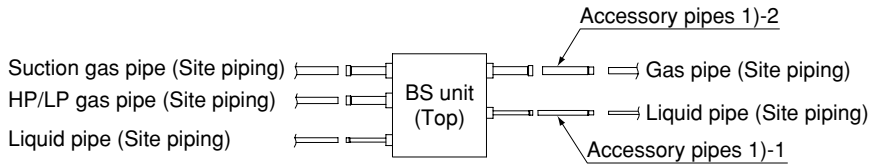

**BS1Q16 type**

When the downstream indoor unit total capacity is more than 100 but less than 150 and when one indoor unit with a capacity of 125 is connected downstream.

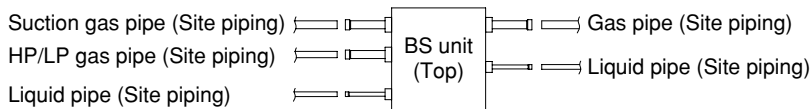

When the downstream indoor unit total capacity is 150 or more but 160 or less

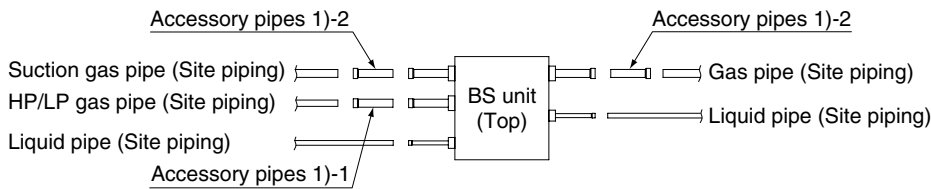

**BS1Q25 type**

When the downstream indoor unit total capacity is more than 160 but less than 200

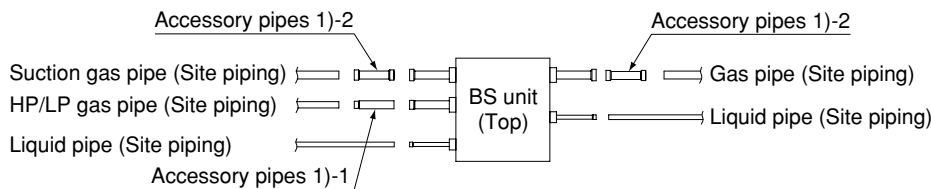

When the downstream indoor unit total capacity is 200 or more but 250 or less and when one indoor unit with a capacity of 250 is connected downstream.

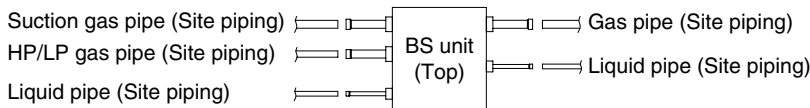

When one indoor unit with a capacity of 200 is connected downstream

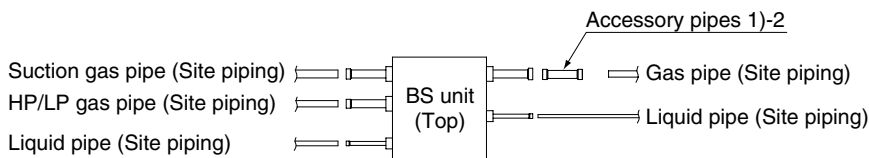

## 6-6 PIPING INSULATION

- After the gas leak inspection is completed, refer to the following figures and use the included insulation tube 3) and clamps 2) to apply the insulation.

### NOTES

- Insulate all of the piping including the liquid pipes, HP/LP gas pipes, suction gas pipes, gas pipes, and the pipe connections for these. Not insulating these pipes could result in water leaks or burns. In particular, suction gas flows in the HP/LP gas pipes during full cooling operation, so the same amount of insulation as used for the suction gas pipes is required. In addition, high-pressure gas flows in the HP/LP gas pipes and gas pipes, so use insulation that can withstand more than 120°C.
- When reinforcing the insulation material for the installation environment, also reinforce the insulation on the piping protruding from the unit and on the pipe connections. Locally purchase the insulation required for the reinforcement work.

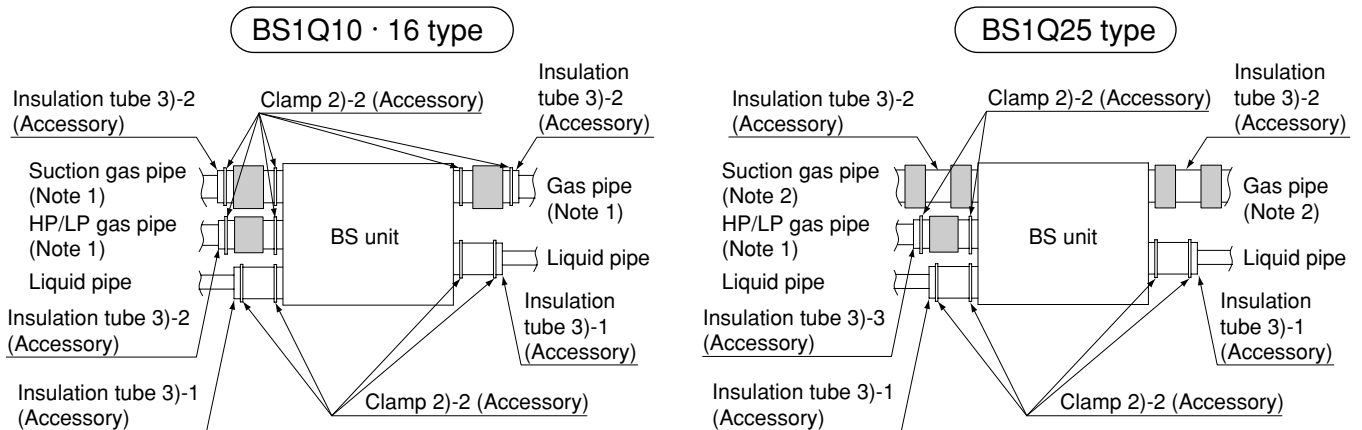

#### Insulation Attachment Instructions

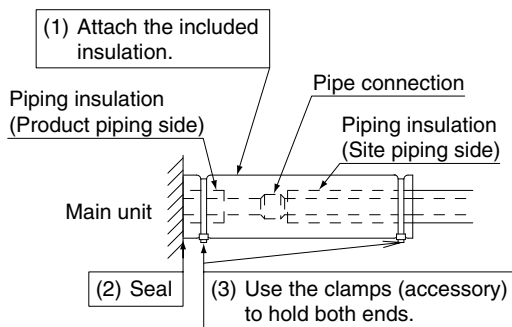

Note 1: For suction gas pipes, HP/LP gas pipes, and gas pipes, after attaching the included insulation tube, wrap more insulation (field supply) around the connections.

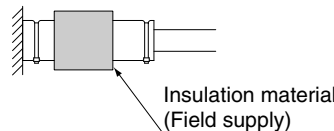

Note 2: For Model Q250, wrap sealing material (field supply) around the insulation tube 3-2 BS unit side and site piping side connections to seal them.

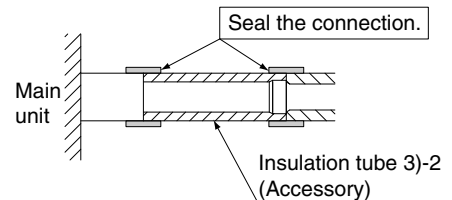

#### Insulation Installation Precautions

- Seal so that air cannot be in and out of the end.
- Do not over tighten the clamp so as to maintain the insulation thickness.
- Be sure to attach the insulation (field supply) with the seams facing up.  
(See figure at right.)

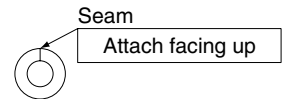

## 7. ELECTRIC WIRING WORK

### 7-1 GENERAL INSTRUCTIONS

- All wiring must be performed by an authorized electrician.
- All field supplied parts and materials, electric works must conform to local codes.
- Always ground wires. (In accordance with national regulations of the pertinent country.)
- Always turn off the power before performing the electric wire installation work.
- Follow the “WIRING DIAGRAM” attached to the unit body to wire the outdoor unit and indoor units.
- Properly connect wire of the specified wire type and copper thickness. Also use the included clamp to avoid applying excessive force to the terminal (field wire, ground wire).
- Do not let the ground wire should come in contact with gas pipes, water pipes, lighting rods, or telephone ground wires.
  - Gas pipes: gas leaks can cause explosions and fire.
  - Water pipes: cannot be grounded if hard vinyl pipes are used.
  - Telephone ground and lightning rods: the ground potential when struck by lightning gets extremely high.
- A circuit breaker capable of shutting down the power supply to the entire system must be installed.
- This system consists of multiple BS units. Mark each BS unit as unit A, unit B . . . , and be sure the terminal board wiring to the outdoor unit and indoor unit are properly matched. If wiring and piping between the outdoor unit, BS unit and an indoor unit are mismatched, the system may cause a malfunction.
- Do not turn on the power supply (branch switches, overload interrupters) until all other work is done.

### 7-2 EXAMPLE FOR THE WHOLE SYSTEM

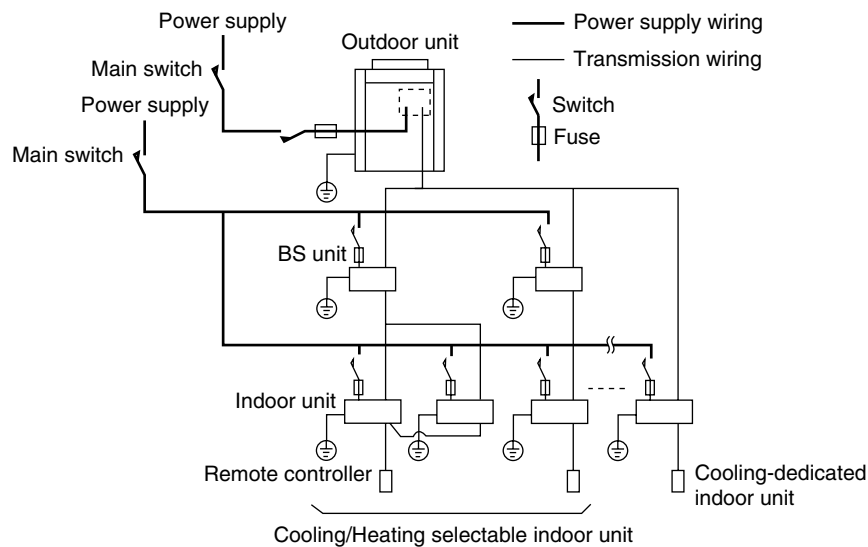

### 7-3 POWER CIRCUIT, SAFETY DEVICE AND CABLE REQUIREMENTS

- A power circuit (Refer to Table 3) must be provided for connection of the unit. This circuit must be protected with the required safety devices, i.e. a main switch, a slow blow fuse on each phase and an earth leakage circuit breaker.
- A main switch or other means for disconnection, having a contact separation in all poles, must be incorporated in the fixed wiring in accordance with relevant local and national legislation.
- When using residual current operated circuit breakers, be sure to use a high-speed type (0.1 second or less) 30mA rated residual operating current.
- Use copper conductors only.
- Use insulated wire for the power cord.
- Select the power supply cable type and size in accordance with relevant local and national regulations.
- Specifications for local wiring are in compliance with IEC60245.
- Use wire type H05VV-U3G for power supply wiring. And the size must comply with local codes.
- Use vinyl cord with sheath or cable (2 wire) of 0.75-1.25mm<sup>2</sup> for transmission wiring.

Table 3

Model	Type	Hz	Units			Power supply	
			Voltage	Min.	Max.	MCA	MFA
BS1Q10	V1	50	220	198	264	0.1	15
BS1Q16			230				
BS1Q25			240				

MCA: Min. Circuit Amps (A);

MFA: Max. Fuse Amps (A)



**NOTES**

- The above Table 3 of Electrical Characteristics refers to one BS unit.
- See the Engineering data book for other details.

**7-4 WIRING EXAMPLE**

- Here is shown a wiring example for one system transmission wiring.
- Connect terminals F1 and F2 (TO IN/D UNIT) on the control PCB (A1P) in the outdoor unit EL. COMPO. BOX and terminals F1 and F2 (TO OUT/D UNIT) of the control PCB (A1P) of the first BS unit A.

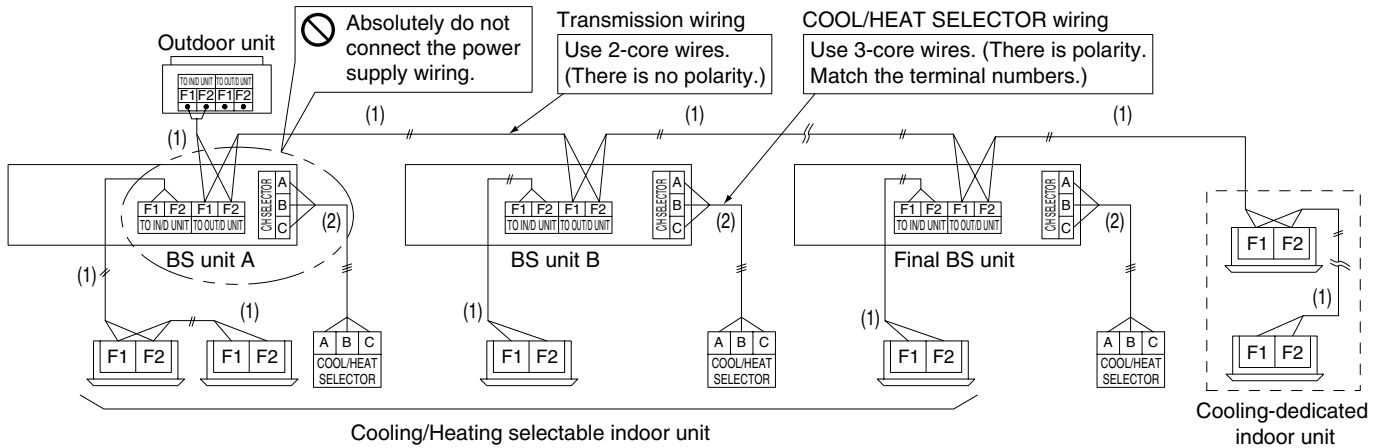

**NOTES**

1. Connect cooling-dedicated air conditioners to terminals F1 and F2 (TO OUT/D UNIT) of the final BS unit.
2. Use 2-core wire for the transmission wiring. Using a multi-core wire with 3 or more cores when two or more indoor units are used at once could cause abnormal stoppage. (Only use 3-core wire in the COOL/HEAT SELECTOR.)
3. Absolutely do not connect the power supply wiring to the transmission wiring terminal block. Doing so could damage the entire system.
4. For the transmission wiring, use wire that is within the following ranges. Exceeding these limits could cause a transmission error.
  - (1) Between an outdoor unit and BS unit,  
Between a BS unit and indoor unit, and  
Between a BS unit and BS unit  
Maximum wiring length: 1000m or less  
Total wiring length: 2000 or less  
Branch point max: 16 branch points
  - (2) Between a BS unit and COOL/HEAT SELECTOR  
Maximum wiring length: 500m or less

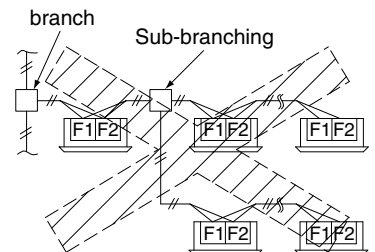

**7-5 WIRING CONNECTIONS**

Remove the EL. COMPO. BOX lid on the side and follow the directions to connect the wires.

**<Transmission wiring>**

Remove the EL. COMPO. BOX lid and connect the wires to F1 and F2 (TO IN/D UNIT) and F1 and F2 (TO OUT/D UNIT) transmission wiring terminals (control PCB (A1P)).

At this time, pass the wiring into the unit through the wiring through hole (left) and use the included clamps 2) to securely hold the wires (in 2 places).

**<Power supply wiring and ground wire>**

Remove the EL. COMPO. BOX lid and connect the power supply wiring to the power terminal block (X1M).

Also connect the ground wire to the ground wire terminal. Pass both the power supply wire and the ground wire together through the wire through hole (right) and into the EL. COMPO. BOX and use the included clamps 2) to securely hold the wires (in 2 places).

Be sure to wire the ground wire so that comes out of the slit in the cup washer.

(Not doing so could cause insufficient ground wire contact and causing the wire not to function as a ground.)

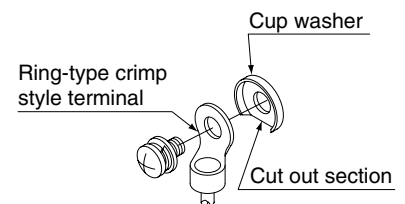

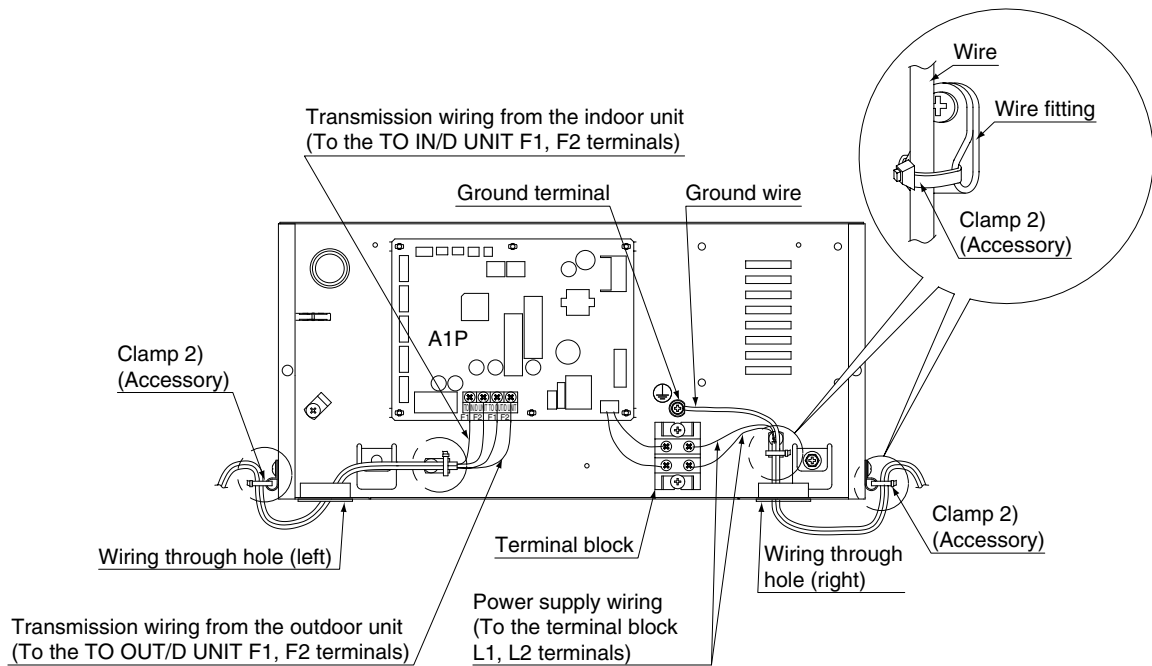

**NOTES**

- Use ring-type crimp style terminal for connections to the power terminal block. **(Refer to Fig. 6)**  
Also, insulate the crimped area by attaching an insulation sleeve, etc.  
If these are not available, see the following section.
- (a) Wiring of different thicknesses cannot be connected to the power terminal block.  
(A loose connection could cause abnormal heating.)
- (b) When connecting wire of the same diameter, make the connection as shown in the figure 7.
- Use an appropriate screwdriver for tightening the terminal screw.  
Using a screwdriver that is too small could damage the screw head and prevent proper tightening.
- Over tightening the terminal screw could damage the screw.  
Refer to the Table 4 for the terminal screw tightening torque.
- When fastening the wire, use the included clamp 2)-1 so as not to apply tensile force to the wire connection and then securely fasten the wire. Also, after wiring is completed, organize the wiring so that the EL. COMPO. BOX lid does not pop up and then properly replace the EL. COMPO. BOX lid.  
Make sure no wires are pinched when replacing the EL. COMPO. BOX lid.  
Always use the wire through hole to protect the wires.
- Do not pass the transmission wiring and power supply wiring through the same locations and outside of the unit keep them separated by at least 50mm.  
Not doing so could cause the transmission wiring to pick up electric noise (external noise) and result in a malfunction or breakdown.
- After the wiring working is complete, use sealer (field supply) to seal closed the wire through hole.  
(Entry by small animals, etc., could cause a malfunction.)

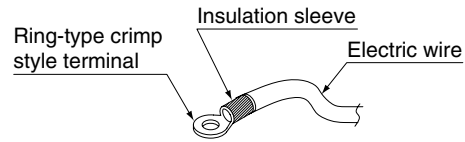

Fig. 6

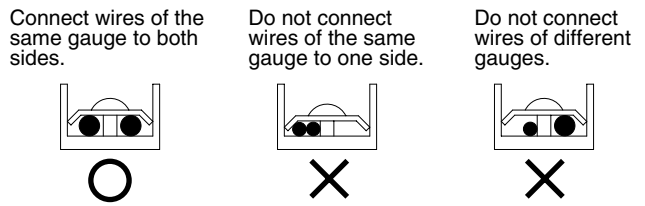

Fig. 7

Table 4

Terminal screw size	Tightening torque (N/m)
M3.5 (COOL/HEAT SELECTOR/transmission wiring terminal block (A1P))	0.80-0.96
M4 (Power supply terminal block)	1.18-1.44
M4 (Ground terminal)	1.52-1.86

## 8. INITIAL SETTING

- When the refrigerant piping and wire installation work is completed, make the following settings as required.

### 1. Setting for when connecting the COOL/HEAT SELECTOR to the BS unit.

#### 〈Setting description〉

Set the input signal from the COOL/HEAT SELECTOR (sold separately) to ON/OFF.

#### 〈Setting method〉

Set the dip switches (DS1-1) on PCB (A1P) as shown at left before turning on the power to the BS unit.

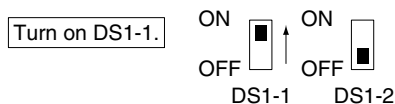

#### NOTES

This setting is read by the microcomputer when the BS unit power is turned on.

- Be sure to make the setting before turning on the power.
- Always close the EL. COMPO. BOX lid after making the setting.

### 2. Setting when changing the “Automatic mode differential” in the Cooling/Heating Automatic Operation Mode.

#### 〈Setting description〉

- The “Automatic mode differential” can be changed within the range of 0°C to 7°C (0°C at factory shipment).
- For details regarding the “Automatic mode differential” and indoor unit operation, refer to the “Engineering data book”.

#### 〈Setting method〉

The setting is made using the “Local Setting Mode” by the remote controller of indoor unit connected to the BS unit.

For information regarding the setting method, refer to “Engineering data book”.

The following table gives a list of the “MODE NO.,” “FIRST CODE NO.,” and “SECOND CODE NO.”

#### NOTES

This setting is operated by the operation remote controller while the indoor unit power is turned on.

- When the indoor unit, outdoor unit, and BS unit installation work is completed, confirm that it is safe even with the power turned on before proceeding with the work.

MODE NO.	FIRST CODE NO.	SECOND CODE NO.	Automatic mode differential (°C)
12 (22)	4	1	0
		2	1
		3	2
		4	3
		5	4
		6	5
		7	6
		8	7

← At factory shipment.

## 9. TEST OPERATION

(1) Check to make sure the EL. COMPO. BOX lid is closed.

(2) Refer to the Installation Manual included with the outdoor unit and conduct a test run.

- Clicking or humming sounds will continue for about 20 sec immediately after the power is turned on due to the start of automatic initialization operation (closing) of the solenoid valve, but this is not a problem.





## 10. WIRING PARTS TABLE

A1P.....	PRINTED CIRCUIT BOARD
DS1, DS2 .....	DIP SWITCH
F1U.....	FUSE (T, 3,15A, 250V)
F2U.....	FIELD FUSE
HAP.....	LIGHT EMITTING DIODE (SERVICE MONITOR - GREEN)
PS.....	SWITCHING POWER SUPPLY (A1P)
Q1DI.....	FIELD EARTH LEAKAGE BREAKER
X1M.....	TERMINAL STRIP (POWER)
X1M (A1P).....	TERMINAL STRIP (CONTROL)
X2M.....	TERMINAL STRIP (C/H SELECTOR)
Y1E.....	ELECTRONIC EXPANSION VALVE (SUB COOL)
Y2E.....	ELECTRONIC EXPANSION VALVE (DISCHARGE)
Y3E.....	ELECTRONIC EXPANSION VALVE (SUCTION)
Z1C.....	NOISE FILTER (FERRITE CORE)

### CONNECTOR FOR OPTIONAL PARTS

X2A.....	CONNECTOR (WIRING EXTERNAL CONTROL ADAPTOR FOR OUTDOOR UNIT)
X38A.....	CONNECTOR (ADAPTOR FOR MULTI TENANT)

### NOTES)

1. THIS WIRING DIAGRAM APPLIES TO THE BS UNIT ONLY.
2.  : TERMINAL STRIP     : CONNECTOR     : TERMINAL  
 : FIELD WIRING     : PROTECTIVE EARTH
3. WHEN USING THE COOL/HEAT SELECTOR (OPTIONAL ACCESSORY), CONNECT IT TO THE TERMINALS A, B AND C ON X2M.
4. AS FOR WIRING TO THE IN/D UNIT (F1)•(F2) AND OUT/D UNIT (F1)•(F2) ON X1M (A1P), REFER TO THE INSTALLATION MANUAL.
5. SYMBOLS SHOW AS FOLLOWS (BLU: BLUE, RED: RED)
6. USE COPPER CONDUCTORS ONLY.
7. DIP SWITCH (DS1, 2) INITIAL SETTINGS ARE AS FOLLOWS.



8. FOR USING DIP SWITCH (DS1, 2), REFER TO INSTALLATION MANUAL OR "SERVICE PRECAUTION" LABEL ON EL. COMPO. BOX.

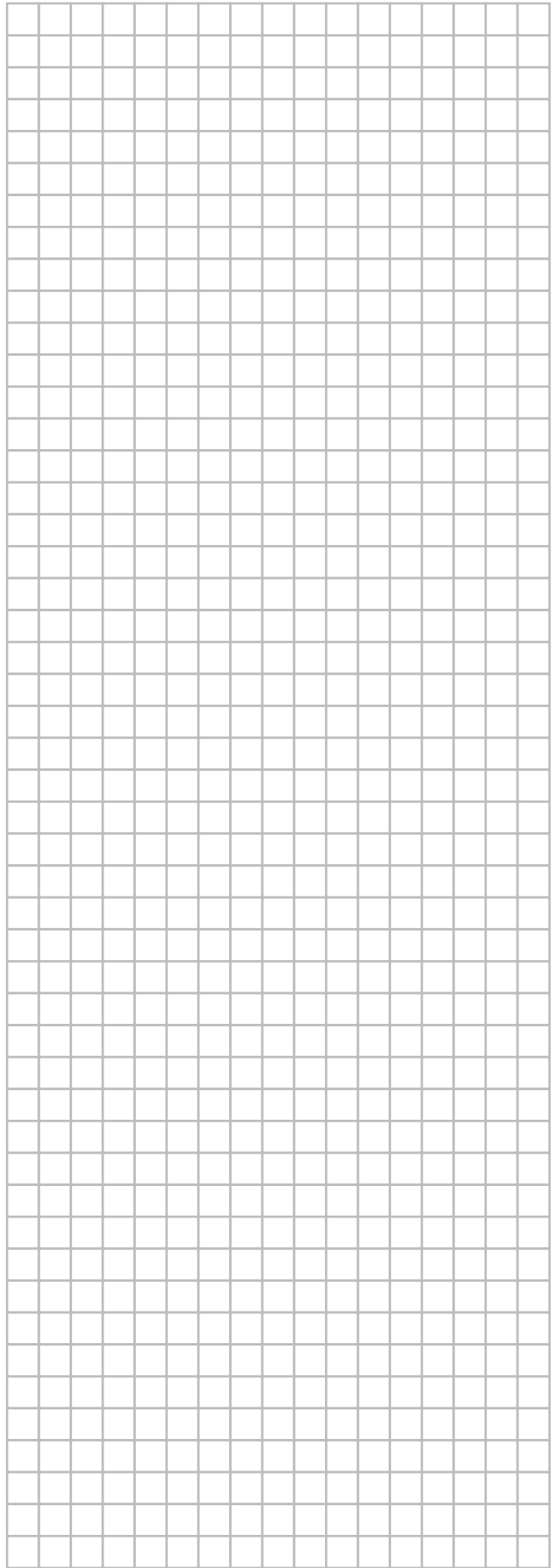
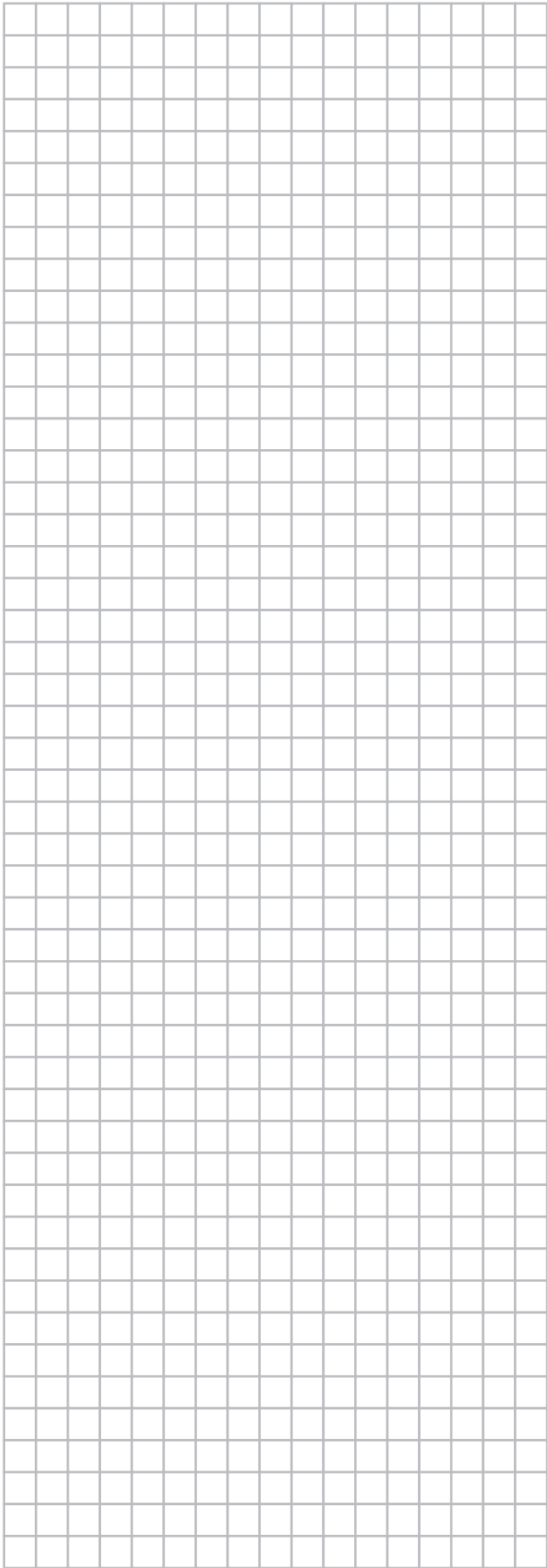







\*4P357812-1 0000000\*

Copyright 2014 Daikin

**DAIKIN EUROPE N.V.**

Zandvoordestraat 300, B-8400 Oostende, Belgium

4P357812-1 2014.01