

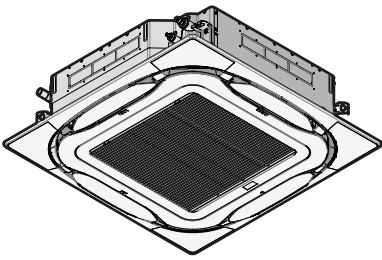

Installer and user reference guide
Split system air conditioners



FCAG35BVEB
FCAG50BVEB
FCAG60BVEB
FCAG71BVEB
FCAG100BVEB
FCAG125BVEB
FCAG140BVEB

Table of contents

1	About the documentation	4
1.1	About this document.....	4
1.2	Meaning of warnings and symbols	5
2	General safety precautions	7
2.1	For the installer	7
2.1.1	General.....	7
2.1.2	Installation site.....	8
2.1.3	Refrigerant — in case of R410A or R32.....	10
2.1.4	Electrical.....	12
3	Specific installer safety instructions	15
For the user		17
4	User safety instructions	18
4.1	General	18
4.2	Instructions for safe operation	19
5	About the system	22
5.1	System layout	22
5.2	Information requirements for fan coil units.....	23
6	User interface	24
7	Before operation	25
8	Operation	26
8.1	Operation range	26
8.2	About operation modes	26
8.2.1	Basic operation modes	26
8.2.2	Special heating operation modes.....	27
8.2.3	Adjusting the airflow direction	27
8.2.4	Active circulation airflow	28
8.3	To operate the system	28
9	Energy saving and optimum operation	29
10	Maintenance and service	30
10.1	Precautions for maintenance and service	30
10.2	Cleaning the air filter, suction grille, air outlet and outside panels	31
10.2.1	To clean the air filter.....	31
10.2.2	To clean the suction grille.....	32
10.2.3	To clean the air outlet and outside panels.....	33
10.3	Maintenance after a long stop period	33
10.4	Maintenance before a long stop period	34
10.5	About the refrigerant	34
11	Troubleshooting	35
11.1	Symptoms that are NOT system malfunctions	36
11.1.1	Symptom: The system does not operate	36
11.1.2	Symptom: The fan speed does not correspond to the setting.....	36
11.1.3	Symptom: The fan direction does not correspond to the setting.....	36
11.1.4	Symptom: White mist comes out of a unit (Indoor unit).....	36
11.1.5	Symptom: White mist comes out of a unit (Indoor unit, outdoor unit).....	36
11.1.6	Symptom: The user interface reads "U4" or "U5" and stops, but then restarts after a few minutes.....	36
11.1.7	Symptom: Noise of air conditioners (Indoor unit)	37
11.1.8	Symptom: Noise of air conditioners (Indoor unit, outdoor unit)	37
11.1.9	Symptom: Dust comes out of the unit	37
11.1.10	Symptom: The units can give off odours.....	37

12 Relocation	38
13 Disposal	39
For the installer	40
14 About the box	41
14.1 Indoor unit.....	41
14.1.1 To unpack and handle the unit.....	41
14.1.2 To remove the accessories from the indoor unit.....	42
15 About the units and options	43
15.1 Identification	43
15.1.1 Identification label: Indoor unit.....	43
15.2 About the indoor unit.....	43
15.3 System layout	43
15.4 Combining units and options	44
15.4.1 Possible options for the indoor unit.....	44
16 Unit installation	45
16.1 Preparing the installation site	45
16.1.1 Installation site requirements of the indoor unit.....	45
16.2 Mounting the indoor unit.....	48
16.2.1 Guidelines when installing the indoor unit	48
16.2.2 Guidelines when installing the drain piping.....	50
17 Piping installation	54
17.1 Preparing refrigerant piping.....	54
17.1.1 Refrigerant piping requirements.....	54
17.1.2 Refrigerant piping insulation	55
17.2 Connecting the refrigerant piping.....	55
17.2.1 About connecting the refrigerant piping	55
17.2.2 Precautions when connecting the refrigerant piping	56
17.2.3 Guidelines when connecting the refrigerant piping	57
17.2.4 Pipe bending guidelines.....	57
17.2.5 To flare the pipe end	57
17.2.6 To connect the refrigerant piping to the indoor unit	58
18 Electrical installation	60
18.1 About connecting the electrical wiring.....	60
18.1.1 Precautions when connecting the electrical wiring.....	60
18.1.2 Guidelines when connecting the electrical wiring.....	61
18.1.3 Specifications of standard wiring components.....	62
18.2 To connect the electrical wiring to the indoor unit.....	63
19 Commissioning	66
19.1 Overview: Commissioning.....	66
19.2 Precautions when commissioning	66
19.3 Checklist before commissioning	67
19.4 To perform a test run.....	67
20 Configuration	68
20.1 Field setting	68
21 Hand-over to the user	72
22 Troubleshooting	73
22.1 Solving problems based on error codes	73
22.1.1 Error codes: Overview	73
23 Disposal	74
24 Technical data	75
24.1 Wiring diagram	75
24.1.1 Unified wiring diagram legend	75
25 Glossary	78

1 About the documentation

1.1 About this document



WARNING

Make sure installation, servicing, maintenance, repair and applied materials follow the instructions from Daikin (including all documents listed in “Documentation set”) and, in addition, comply with applicable legislation and are performed by qualified persons only. In Europe and areas where IEC standards apply, EN/IEC 60335-2-40 is the applicable standard.

Target audience

Authorised installers + end users



INFORMATION

This appliance is intended to be used by expert or trained users in shops, in light industry, and on farms, or for commercial and household use by lay persons.

Documentation set

This document is part of a documentation set. The complete set consists of:

- **General safety precautions:**
 - Safety instructions that you must read before installing
 - Format: Paper (in the box of the indoor unit)
- **Indoor unit installation and operation manual:**
 - Installation and operation instructions
 - Format: Paper (in the box of the indoor unit)
- **Installer and user reference guide:**
 - Preparation of the installation, good practices, reference data,...
 - Detailed step-by-step instructions and background information for basic and advanced usage
 - Format: Digital files on <https://www.daikin.eu>. Use the search function 🔍 to find your model.

The latest revision of the supplied documentation is published on the regional Daikin website and is available via your dealer.

Scan the QR code below to find the full documentation set and more information about your product on the Daikin website.











The original instructions are written in English. All other languages are translations of the original instructions.





Technical engineering data

- A **subset** of the latest technical data is available on the regional Daikin website (publicly accessible).
- The **full set** of the latest technical data is available on the Daikin Business Portal (authentication required).

1.2 Meaning of warnings and symbols



	DANGER Indicates a situation that results in death or serious injury.
	DANGER: RISK OF ELECTROCUTION Indicates a situation that could result in electrocution.
	DANGER: RISK OF BURNING/SCALDING Indicates a situation that could result in burning/scalding because of extreme hot or cold temperatures.
	DANGER: RISK OF EXPLOSION Indicates a situation that could result in explosion.
	WARNING Indicates a situation that could result in death or serious injury.
	WARNING: FLAMMABLE MATERIAL
	CAUTION Indicates a situation that could result in minor or moderate injury.
	NOTICE Indicates a situation that could result in equipment or property damage.
	INFORMATION Indicates useful tips or additional information.

Symbols used on the unit:

Symbol	Explanation
	Before installation, read the installation and operation manual, and the wiring instruction sheet.
	Before performing maintenance and service tasks, read the service manual.
	For more information, see the installer and user reference guide.
	The unit contains rotating parts. Be careful when servicing or inspecting the unit.

Symbols used in the documentation:

Symbol	Explanation
	Indicates a figure title or a reference to it. Example: "▲ 1-3 Figure title" means "Figure 3 in chapter 1".

Symbol	Explanation
	Indicates a table title or a reference to it. Example: "  1-3 Table title" means "Table 3 in chapter 1".

2 General safety precautions

2.1 For the installer

2.1.1 General

If you are NOT sure how to install or operate the unit, contact your dealer.



DANGER: RISK OF BURNING/SCALDING

- Do NOT touch the refrigerant piping, water piping or internal parts during and immediately after operation. It could be too hot or too cold. Give it time to return to normal temperature. If you MUST touch it, wear protective gloves.
- Do NOT touch any accidental leaking refrigerant.



WARNING

Improper installation or attachment of equipment or accessories could result in electrical shock, short-circuit, leaks, fire or other damage to the equipment. ONLY use accessories, optional equipment and spare parts made or approved by Daikin unless otherwise specified.



WARNING

Make sure installation, testing and applied materials comply with applicable legislation (on top of the instructions described in the Daikin documentation).



WARNING

Tear apart and throw away plastic packaging bags so that nobody, especially children, can play with them. **Possible consequence:** suffocation.



WARNING

Provide adequate measures to prevent that the unit can be used as a shelter by small animals. Small animals that make contact with electrical parts can cause malfunctions, smoke or fire.



CAUTION

Wear adequate personal protective equipment (protective gloves, safety glasses,...) when installing, maintaining or servicing the system.



CAUTION

Do NOT touch the air inlet or aluminium fins of the unit.



CAUTION

- Do NOT place any objects or equipment on top of the unit.
- Do NOT sit, climb or stand on the unit.

In accordance with the applicable legislation, it might be necessary to provide a logbook with the product containing at least: information on maintenance, repair work, results of tests, stand-by periods,...

Also, at least, following information MUST be provided at an accessible place at the product:

- Instructions for shutting down the system in case of an emergency

- Name and address of fire department, police and hospital
- Name, address and day and night telephone numbers for obtaining service

In Europe, EN378 provides the necessary guidance for this logbook.

2.1.2 Installation site

- Provide sufficient space around the unit for servicing and air circulation.
- Make sure the installation site withstands the weight and vibration of the unit.
- Make sure the area is well ventilated. Do NOT block any ventilation openings.
- Make sure the unit is level.

Do NOT install the unit in the following places:

- In potentially explosive atmospheres.
- In places where there is machinery that emits electromagnetic waves. Electromagnetic waves may disturb the control system, and cause malfunction of the equipment.
- In places where there is a risk of fire due to the leakage of flammable gases (example: thinner or gasoline), carbon fibre, ignitable dust.
- In places where corrosive gas (example: sulphurous acid gas) is produced. Corrosion of copper pipes or soldered parts may cause the refrigerant to leak.

Instructions for equipment using R32 refrigerant



WARNING

- Do NOT pierce or burn refrigerant cycle parts.
- Do NOT use cleaning materials or means to accelerate the defrosting process other than those recommended by the manufacturer.
- Be aware that the refrigerant inside the system is odourless.



WARNING

The appliance shall be stored so as to prevent mechanical damage and in a well-ventilated room without continuously operating ignition sources (example: open flames, an operating gas appliance or an operating electric heater) and have a room size as specified below.



WARNING

Make sure installation, servicing, maintenance and repair comply with instructions from Daikin and with applicable legislation (for example national gas regulation) and are executed ONLY by authorised persons.



WARNING

- Take precautions to avoid excessive vibration or pulsation to refrigeration piping.
- Protect the protection devices, piping and fittings as much as possible against adverse environmental effects.
- Provide space for expansion and contraction of long runs of piping.
- Design and install piping in refrigerating systems such as to minimise the likelihood of hydraulic shock damaging the system.
- Mount the indoor equipment and pipes securely and protect them to avoid accidental rupture of equipment or pipes in case of events such as moving furniture or reconstruction activities.



WARNING

If one or more rooms are connected to the unit using a duct system, make sure:

- there are no operating ignition sources (example: open flames, an operating gas appliance or an operating electric heater) in case the floor area is less than the minimum floor area A (m²).
- no auxiliary devices, which may be a potential ignition source, are installed in the duct work (example: hot surfaces with a temperature exceeding 700°C and electric switching device);
- only auxiliary devices approved by the manufacturer are used in the duct work;
- air inlet AND outlet are connected directly to the same room by ducting. Do NOT use spaces such as a false ceiling as a duct for the air inlet or outlet.



CAUTION

- Incomplete flaring may cause refrigerant gas leakage.
- Do NOT re-use flares. Use new flares to prevent refrigerant gas leakage.
- Use flare nuts that are included with the unit. Using different flare nuts may cause refrigerant gas leakage.



CAUTION

Do NOT use potential sources of ignition in searching for or detection of refrigerant leaks.



NOTICE

- Do NOT re-use joints and copper gaskets which have been used already.
- Joints made in the installation between parts of the refrigerant system shall be accessible for maintenance purposes.

Installation space requirements



WARNING

If appliances contain R32 refrigerant, the floor area of the room in which the appliances are installed, operated and stored MUST be larger than the minimum floor area defined in table below A (m²). This applies to:

- Indoor units **without** a refrigerant leakage sensor; in case of indoor units **with** refrigerant leakage sensor, consult the installation manual
- Outdoor units installed or stored indoors (e.g. winter garden, garage, machinery room)



NOTICE

- The pipework shall be securely mounted and guarded protected from physical damage.
- Keep the pipework installation to a minimum.

To determine the minimum floor area

- 1 Determine the total refrigerant charge in the system (= factory refrigerant charge ① + ② additional refrigerant amount charged).

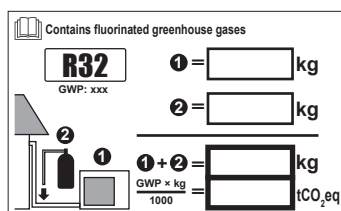

2 Determine which graph or table to use.

- For indoor units: Is the unit ceiling-mounted, wall-mounted or floor-standing?
- For outdoor units installed or stored indoors, this depends on the installation height:

If the installation height is...	Then use the graph or table for...
<1.8 m	Floor-standing units
1.8≤x<2.2 m	Wall-mounted units
≥2.2 m	Ceiling-mounted units

3 Use the graph or table to determine the minimum floor area.

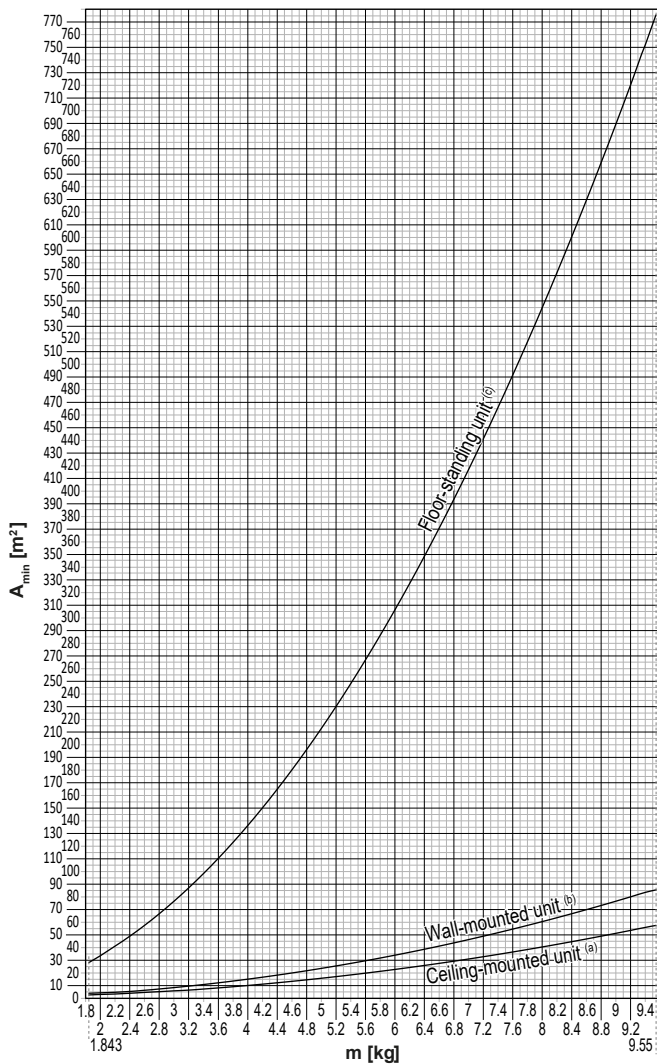

Ceiling-mounted unit ^(a)		Wall-mounted unit ^(b)		Floor-standing unit ^(c)	
m (kg)	A _{min} (m ²)	m (kg)	A _{min} (m ²)	m (kg)	A _{min} (m ²)
≤1.842	—	≤1.842	—	≤1.842	—
1.843	3.64	1.843	4.45	1.843	28.9
2.0	3.95	2.0	4.83	2.0	34.0
2.2	4.34	2.2	5.31	2.2	41.2
2.4	4.74	2.4	5.79	2.4	49.0
2.6	5.13	2.6	6.39	2.6	57.5
2.8	5.53	2.8	7.41	2.8	66.7
3.0	5.92	3.0	8.51	3.0	76.6
3.2	6.48	3.2	9.68	3.2	87.2
3.4	7.32	3.4	10.9	3.4	98.4
3.6	8.20	3.6	12.3	3.6	110
3.8	9.14	3.8	13.7	3.8	123
4.0	10.1	4.0	15.1	4.0	136
4.2	11.2	4.2	16.7	4.2	150
4.4	12.3	4.4	18.3	4.4	165
4.6	13.4	4.6	20.0	4.6	180
4.8	14.6	4.8	21.8	4.8	196
5.0	15.8	5.0	23.6	5.0	213
5.2	17.1	5.2	25.6	5.2	230
5.4	18.5	5.4	27.6	5.4	248
5.6	19.9	5.6	29.7	5.6	267
5.8	21.3	5.8	31.8	5.8	286
6.0	22.8	6.0	34.0	6.0	306
6.2	24.3	6.2	36.4	6.2	327
6.4	25.9	6.4	38.7	6.4	349
6.6	27.6	6.6	41.2	6.6	371
6.8	29.3	6.8	43.7	6.8	394
7.0	31.0	7.0	46.3	7.0	417
7.2	32.8	7.2	49.0	7.2	441
7.4	34.7	7.4	51.8	7.4	466
7.6	36.6	7.6	54.6	7.6	492
7.8	38.5	7.8	57.5	7.8	518
8	40.5	8	60.5	8	545
8.2	42.6	8.2	63.6	8.2	572
8.4	44.7	8.4	66.7	8.4	601
8.6	46.8	8.6	69.9	8.6	629
8.8	49.0	8.8	73.2	8.8	659
9	51.3	9	76.6	9	689
9.2	53.6	9.2	80.0	9.2	720
9.4	55.9	9.4	83.6	9.4	752
9.55	57.7	9.55	86.2	9.55	776

- m** Total refrigerant charge in the system
- A_{min}** Minimum floor area
- (a)** Ceiling-mounted unit (= Ceiling-mounted unit)
- (b)** Wall-mounted unit (= Wall-mounted unit)
- (c)** Floor-standing unit (= Floor-standing unit)

2.1.3 Refrigerant — in case of R410A or R32

If applicable. See the installation manual or installer reference guide of your application for more information.

**DANGER: RISK OF EXPLOSION**

Pump down – Refrigerant leakage. If you want to pump down the system, and there is a leak in the refrigerant circuit:

- Do NOT use the unit's automatic pump down function, with which you can collect all refrigerant from the system into the outdoor unit. **Possible consequence:** Self-combustion and explosion of the compressor because of air going into the operating compressor.
- Use a separate recovery system so that the unit's compressor does NOT have to operate.

**WARNING**

During tests, NEVER pressurise the product with a pressure higher than the maximum allowable pressure (as indicated on the nameplate of the unit).

**WARNING**

Take sufficient precautions in case of refrigerant leakage. If refrigerant gas leaks, ventilate the area immediately. Possible risks:

- Excessive refrigerant concentrations in a closed room can lead to oxygen deficiency.
- Toxic gas might be produced if refrigerant gas comes into contact with fire.

**WARNING**

ALWAYS recover the refrigerant. Do NOT release directly into the environment. Use a vacuum pump to evacuate the installation.

**WARNING**

Make sure there is no oxygen in the system. Refrigerant may ONLY be charged after performing the leak test and the vacuum drying.

Possible consequence: Self-combustion and explosion of the compressor because of oxygen going into the operating compressor.

**NOTICE**

- To avoid compressor breakdown, do NOT charge more than the specified amount of refrigerant.
- When the refrigerant system is to be opened, refrigerant MUST be treated according to the applicable legislation.

**NOTICE**

Make sure refrigerant piping installation complies with applicable legislation. In Europe, EN378 is the applicable standard.

**NOTICE**



Make sure the field piping and connections are NOT subjected to stress.

**NOTICE**

After all the piping has been connected, make sure there is no gas leak. Use nitrogen to perform a gas leak detection.

- In case recharge is required, see the nameplate or the refrigerant charge label of the unit. It states the type of refrigerant and necessary amount.

- Whether the unit is factory charged with refrigerant or non-charged, in both cases you might need to charge additional refrigerant, depending on the pipe sizes and pipe lengths of the system.
- ONLY use tools exclusively for the refrigerant type used in the system, this to ensure pressure resistance and prevent foreign materials from entering into the system.
- Charge the liquid refrigerant as follows:

If	Then
A siphon tube is present (i.e., the cylinder is marked with "Liquid filling siphon attached")	Charge with the cylinder upright. 
A siphon tube is NOT present	Charge with the cylinder upside down. 

- Open refrigerant cylinders slowly.
- Charge the refrigerant in liquid form. Adding it in gas form may prevent normal operation.



CAUTION

When the refrigerant charging procedure is done or when pausing, close the valve of the refrigerant tank immediately. If the valve is NOT closed immediately, remaining pressure might charge additional refrigerant. **Possible consequence:** Incorrect refrigerant amount.

2.1.4 Electrical



DANGER: RISK OF ELECTROCUTION

- Turn OFF all power supply before removing the switch box cover, connecting electrical wiring or touching electrical parts.
- Disconnect the power supply for more than 10 minutes, and measure the voltage at the terminals of main circuit capacitors or electrical components before servicing. The voltage MUST be less than 50 V DC before you can touch electrical components. For the location of the terminals, see the wiring diagram.
- Do NOT touch electrical components with wet hands.
- Do NOT leave the unit unattended when the service cover is removed.



WARNING

If NOT factory installed, a main switch or other means for disconnection, having a contact separation in all poles providing full disconnection under overvoltage category III condition, MUST be installed in the fixed wiring.

**WARNING**

- ONLY use copper wires.
- Make sure the field wiring complies with the national wiring regulations.
- All field wiring **MUST** be performed in accordance with the wiring diagram supplied with the product.
- NEVER squeeze bundled cables and make sure they do NOT come in contact with the piping and sharp edges. Make sure no external pressure is applied to the terminal connections.
- Make sure to install earth wiring. Do NOT earth the unit to a utility pipe, surge absorber, or telephone earth. Incomplete or incorrect earthing may cause electrical shock.
- Make sure to use a dedicated power circuit. NEVER use a power supply shared by another appliance.
- Make sure to install the required fuses or circuit breakers.
- Make sure to install an earth leakage protector. Failure to do so may cause electrical shock or fire.
- When installing the earth leakage protector, make sure it is compatible with the inverter (resistant to high frequency electric noise) to avoid unnecessary opening of the earth leakage protector.

**WARNING**

- After finishing the electrical work, confirm that each electrical component and terminal inside the switch box is connected securely.
- Make sure all covers are closed before starting up the unit.

**CAUTION**

- When connecting the power supply: connect the earth cable first, before making the current-carrying connections.
- When disconnecting the power supply: disconnect the current-carrying cables first, before separating the earth connection.
- The length of the conductors between the power supply stress relief and the terminal block itself **MUST** be as such that the current-carrying wires are tautened before the earth wire is in case the power supply is pulled loose from the stress relief.

**NOTICE**

Precautions when laying power wiring:



- Do NOT connect wiring of different thicknesses to the power terminal block (slack in the power wiring may cause abnormal heat).
- When connecting wiring which is the same thickness, do as shown in the figure above.
- For wiring, use the designated power wire and connect firmly, then secure to prevent outside pressure being exerted on the terminal board.
- Use an appropriate screwdriver for tightening the terminal screws. A screwdriver with a small head will damage the head and make proper tightening impossible.
- Over-tightening the terminal screws may break them.

Install power cables at least 1 meter away from televisions or radios to prevent interference. Depending on the radio waves, a distance of 1 meter may NOT be sufficient.

**NOTICE**

ONLY applicable if the power supply is three-phase, and the compressor has an ON/OFF starting method.

If there exists the possibility of reversed phase after a momentary black out and the power goes ON and OFF while the product is operating, attach a reversed phase protection circuit locally. Running the product in reversed phase can break the compressor and other parts.

3 Specific installer safety instructions

Always observe the following safety instructions and regulations.

General



WARNING

Make sure installation, servicing, maintenance, repair and applied materials follow the instructions from Daikin (including all documents listed in "Documentation set") and, in addition, comply with applicable legislation and are performed by qualified persons only. In Europe and areas where IEC standards apply, EN/IEC 60335-2-40 is the applicable standard.



WARNING: MILDLY FLAMMABLE MATERIAL

The R32 refrigerant (if applicable) in this unit is mildly flammable. Refer to the outdoor unit specifications for the type of refrigerant to be used.

Unit installation (see "16 Unit installation" [▶ 45])



WARNING

The appliance using R32 refrigerant shall be stored so as to prevent mechanical damage and in a well-ventilated room without continuously operating ignition sources (e.g. open flames, an operating gas appliance, or an operating electric heater). The room size shall be as specified in the General safety precaution.



CAUTION

Appliance NOT accessible to the general public, install it in a secured area, protected from easy access.

This unit, both indoor and outdoor, is suitable for installation in a commercial and light industrial environment.

Refrigerant piping installation (see "17 Piping installation" [▶ 54])



CAUTION

Piping MUST be installed according to instructions given in "17 Piping installation" [▶ 54]. Only mechanical joints (e.g. braze+flare connections) that are compliant with the latest version of ISO14903 can be used.



CAUTION

Install the refrigerant piping or components in a position where they are unlikely to be exposed to any substance which may corrode components containing refrigerant, unless the components are constructed of materials that are inherently resistant to corrosion or are suitably protected against corrosion.

Electrical installation (see "18 Electrical installation" [▶ 60])



WARNING

ALWAYS use multicore cable for power supply cables.



WARNING

- All wiring **MUST** be performed by an authorised electrician and **MUST** comply with the national wiring regulation.
- Make electrical connections to the fixed wiring.
- All components procured on-site and all electrical construction **MUST** comply with the applicable legislation.



WARNING

- If the power supply has a missing or wrong N-phase, equipment might break down.
- Establish proper earthing. Do **NOT** earth the unit to a utility pipe, surge absorber, or telephone earth. Incomplete earthing may cause electrical shocks.
- Install the required fuses or circuit breakers.
- Secure the electrical wiring with cable ties so that the cables do **NOT** come in contact with sharp edges or piping, particularly on the high-pressure side.
- Do **NOT** install a phase advancing capacitor, because this unit is equipped with an inverter. A phase advancing capacitor will reduce performance and may cause accidents.



WARNING

Use an all-pole disconnection type breaker with at least 3 mm between the contact point gaps that provides full disconnection under overvoltage category III.



WARNING

If the supply cord is damaged, it **MUST** be replaced by the manufacturer, its service agent or similarly qualified persons in order to avoid a hazard.



WARNING

Do **NOT** extend the power supply or the interconnection cable by using wire connectors, wire connection clamps, taped wires, extension cords. These can cause overheating, electric shock or fire.

Commissioning (see "19 Commissioning" [▶ 66])



WARNING

If the panels on the indoor units are not installed yet, make sure to power **OFF** the system after finishing the test run. To do so, turn **OFF** operation via the user interface. Do **NOT** stop operation by turning **OFF** the circuit breakers.

For the user

4 User safety instructions

Always observe the following safety instructions and regulations.

4.1 General



WARNING

If you are NOT sure how to operate the unit, contact your installer.



WARNING

This appliance can be used by children aged from 8 years and above and persons with reduced physical, sensory or mental capabilities or lack of experience and knowledge if they have been given supervision or instruction concerning use of the appliance in a safe way and understand the hazards involved.

Children SHALL NOT play with the appliance.

Cleaning and user maintenance SHALL NOT be made by children without supervision.



WARNING

To prevent electrical shocks or fire:

- Do NOT rinse the unit.
- Do NOT operate the unit with wet hands.
- Do NOT place any objects containing water on the unit.



CAUTION

- Do NOT place any objects or equipment on top of the unit.
- Do NOT sit, climb or stand on the unit.

- Units are marked with the following symbol:



This means that electrical and electronic products may NOT be mixed with unsorted household waste. Do NOT try to dismantle the system yourself: dismantling the system, treatment of the refrigerant, of oil and of other parts MUST be done by an authorised installer and MUST comply with applicable legislation.

Units MUST be treated at a specialised treatment facility for reuse, recycling and recovery. By ensuring this product is disposed of correctly, you will help to prevent potential negative consequences for the environment and human health. For more information, contact your installer or local authority.

- Batteries are marked with the following symbol:



This means that the batteries may NOT be mixed with unsorted household waste. If a chemical symbol is printed beneath the symbol, this chemical symbol means that the battery contains a heavy metal above a certain concentration.

Possible chemical symbols are: Pb: lead (>0.004%).

Waste batteries MUST be treated at a specialised treatment facility for reuse. By ensuring waste batteries are disposed of correctly, you will help to prevent potential negative consequences for the environment and human health.

4.2 Instructions for safe operation



WARNING

- Do NOT modify, disassemble, remove, reinstall or repair the unit yourself as incorrect dismantling or installation may cause an electrical shock or fire. Contact your dealer.
- In case of accidental refrigerant leaks, make sure there are no naked flames. The refrigerant itself is entirely safe, non-toxic and non-combustible, but it will generate toxic gas when it accidentally leaks into a room where combustion air from fan heaters, gas cookers, etc. is present. ALWAYS have qualified service personnel confirm that the point of leakage has been repaired or corrected before resuming operation.



CAUTION

- NEVER touch the internal parts of the controller.
- Do NOT remove the front panel. Some parts inside are dangerous to touch and appliance problems may happen. For checking and adjusting the internal parts, contact your dealer.



WARNING

This unit contains electrical and hot parts.



WARNING

Before operating the unit, be sure the installation has been carried out correctly by an installer.



CAUTION

It is unhealthy to expose your body to the air flow for a long time.



CAUTION

To avoid oxygen deficiency, ventilate the room sufficiently if equipment with burner is used together with the system.



CAUTION

Do NOT operate the system when using a room fumigation-type insecticide. Chemicals could collect in the unit, and endanger the health of people who are hypersensitive to chemicals.



WARNING

NEVER touch the air outlet or the horizontal blades while the swing flap is in operation. Fingers may become caught or the unit may break down.



CAUTION

NEVER expose little children, plants or animals directly to the airflow.



WARNING

Do NOT place a flammable spray bottle near the air conditioner and do NOT use sprays near the unit. Doing so may result in a fire.

Maintenance and service (see "10 Maintenance and service" [▶ 30])



CAUTION: Pay attention to the fan!

It is dangerous to inspect the unit while the fan is running.
Make sure to turn OFF the main switch before executing any maintenance task.



CAUTION

Do NOT insert fingers, rods or other objects into the air inlet or outlet. When the fan is rotating at high speed, it will cause injury.



WARNING

NEVER replace a fuse with a fuse of a wrong ampere ratings or other wires when a fuse blows out. Use of wire or copper wire may cause the unit to break down or cause a fire.



CAUTION

After a long use, check the unit stand and fitting for damage. If damaged, the unit may fall and result in injury.



DANGER: RISK OF ELECTROCUTION

To clean the air conditioner or air filter, be sure to stop operation and turn all power supplies OFF. Otherwise, an electrical shock and injury may result.



WARNING

Be careful with ladders when working in high places.



CAUTION

Turn off the unit before cleaning the air filter, suction grille, air outlet and outside panels.



CAUTION

Before accessing terminal devices, make sure to interrupt all power supply.



WARNING

Do NOT let the indoor unit get wet. **Possible consequence:** Electrical shock or fire.

**DANGER: RISK OF ELECTROCUTION**

Disconnect the power supply for more than 10 minutes, and measure the voltage at the terminals of main circuit capacitors or electrical components before servicing. The voltage **MUST** be less than 50 V DC before you can touch electrical components. For the location of the terminals, see the warning label for persons performing service and maintenance.

About the refrigerant (see "10.5 About the refrigerant" [▶ 34])**WARNING: MILDLY FLAMMABLE MATERIAL**

The R32 refrigerant (if applicable) in this unit is mildly flammable. Refer to the outdoor unit specifications for the type of refrigerant to be used.

**WARNING**

The appliance using R32 refrigerant shall be stored so as to prevent mechanical damage and in a well-ventilated room without continuously operating ignition sources (e.g. open flames, an operating gas appliance, or an operating electric heater). The room size shall be as specified in the General safety precaution.

**WARNING**

- Do NOT pierce or burn refrigerant cycle parts.
- Do NOT use cleaning materials or means to accelerate the defrosting process other than those recommended by the manufacturer.
- Be aware that the refrigerant inside the system is odourless.

**WARNING**

- R410A is a non-combustible refrigerant, and R32 is a mildly flammable refrigerant; they normally do NOT leak. If the refrigerant leaks in the room and comes into contact with fire from a burner, a heater, or a cooker, this may result in a fire (in case of R32), or the formation of a harmful gas.
- Turn OFF any combustible heating devices, ventilate the room, and contact the dealer from where you purchased the unit.
- Do NOT use the unit until a service person confirms that the part from which the refrigerant leaked has been repaired.

Troubleshooting (see "11 Troubleshooting" [▶ 35])**WARNING**

Stop operation and shut OFF the power if anything unusual occurs (burning smells etc.).

Leaving the unit running under such circumstances may cause breakage, electrical shock or fire. Contact your dealer.

5 About the system

The indoor unit of this split system air conditioner can be used for heating/cooling applications.



WARNING

- Do NOT modify, disassemble, remove, reinstall or repair the unit yourself as incorrect dismantling or installation may cause an electrical shock or fire. Contact your dealer.
- In case of accidental refrigerant leaks, make sure there are no naked flames. The refrigerant itself is entirely safe and non-toxic. R410A is a non-combustible refrigerant, and R32 is a mildly flammable refrigerant, but they will generate a toxic gas when they accidentally leak into a room where combustible air from fan heaters, gas cookers, etc. is present. Always have qualified service personnel confirm that the point of leakage has been repaired or corrected before resuming operation.



NOTICE

Do NOT use the system for other purposes. In order to avoid any quality deterioration, do NOT use the unit for cooling precision instruments, food, plants, animals, or works of art.



NOTICE

For future modifications or expansions of your system:

A full overview of allowable combinations (for future system extensions) is available in technical engineering data and should be consulted. Contact your installer to receive more information and professional advice.

5.1 System layout



INFORMATION

The following figure is an example and may NOT completely match your system layout.

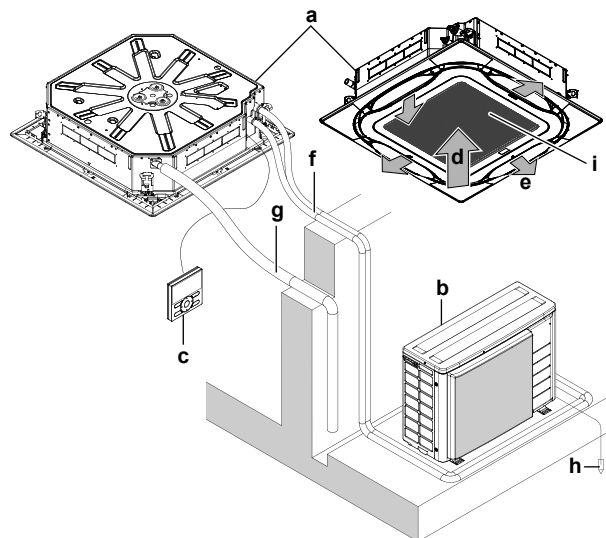

- a** Indoor unit
- b** Outdoor unit
- c** User interface
- d** Suction air

- e** Discharge air
- f** Refrigerant piping + interconnection cable
- g** Drain pipe
- h** Earth wiring
- i** Suction grille and air filter

5.2 Information requirements for fan coil units

Item	Symbol	Value	Unit
Cooling capacity (sensible)	$P_{rated,c}$	A	kW
Cooling capacity (latent)	$P_{rated,c}$	B	kW
Heating capacity	$P_{rated,h}$	C	kW
Total electric power input	P_{elec}	D	kW
Sound power level (cooling)	L_{WA}	E	dB(A)
Sound power level (heating)	L_{WA}	F	dB(A)
Contact details: DAIKIN INDUSTRIES CZECH REPUBLIC s.r.o. U Nové Hospody 1155/1, 301 00 Plzeň Skvrňany, Czech Republic			

	A	B	C	D	E
FCAG125	8.71	3.39	13.50	0.17	58
FCAG140	8.68	4.72	15.50	0.17	58

6 User interface



CAUTION

- NEVER touch the internal parts of the controller.
- Do NOT remove the front panel. Some parts inside are dangerous to touch and appliance problems may happen. For checking and adjusting the internal parts, contact your dealer.

This operation manual offers a non-exhaustive overview of the main functions of the system.



NOTICE

Do NOT wipe the controller operation panel with benzine, thinner, chemical dust cloth, etc. The panel may get discoloured or the coating peeled off. If it is heavily dirty, soak a cloth in water-diluted neutral detergent, squeeze it well and wipe the panel clean. Wipe it with another dry cloth.



NOTICE

NEVER press the button of the user interface with a hard, pointed object. The user interface may be damaged.



NOTICE

NEVER pull or twist the electric wire of the user interface. It may cause the unit to malfunction.

For more information about the user interface, see the operation manual of the installed user interface.

7 Before operation

**WARNING**

This unit contains electrical and hot parts.

**WARNING**

Before operating the unit, be sure the installation has been carried out correctly by an installer.

**CAUTION**

It is unhealthy to expose your body to the air flow for a long time.

**CAUTION**

To avoid oxygen deficiency, ventilate the room sufficiently if equipment with burner is used together with the system.

**CAUTION**

Do NOT operate the system when using a room fumigation-type insecticide. Chemicals could collect in the unit, and endanger the health of people who are hypersensitive to chemicals.

This operation manual is for the following systems with standard control. Before initiating operation, contact your dealer for the operation that corresponds to your system type and mark. If your installation has a customised control system, ask your dealer for the operation that corresponds to your system.

8 Operation

8.1 Operation range



INFORMATION

For the operation limits see the technical data of the connected outdoor unit.

8.2 About operation modes







INFORMATION

Depending on the installed system, some operation modes will not be available.



- The air flow rate may adjust itself depending on the room temperature or the fan may stop immediately. This is not a malfunction.
- If the main power supply is turned off during operation, operation will restart automatically after the power turns back on again.
- **Setpoint.** Target temperature for the Cooling, Heating, and Auto operation modes.
- **Setback.** A function that keeps the room temperature in a specific range when the system is turned off (by the user, the schedule function, or the OFF timer).

8.2.1 Basic operation modes

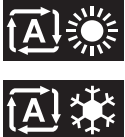
The indoor unit can operate in various operation modes.



Icon	Operation mode
	Cooling. In this mode, cooling will be activated as required by the setpoint, or by Setback operation.
	Heating. In this mode, heating will be activated as required by the setpoint, or by Setback operation.
	Fan only. In this mode, air circulates without heating or cooling.
	Dry. In this mode, the air humidity will be lowered with a minimal temperature decrease. The temperature and fan speed are controlled automatically and cannot be controlled by the controller. Dry operation will not function if the room temperature is too low.
	Auto. In Auto mode, the indoor unit automatically switches between heating and cooling mode, as required by the setpoint.

8.2.2 Special heating operation modes

Operation	Description
Defrost	<p>To prevent a loss of heating capacity due to frost accumulation in the outdoor unit, the system will automatically switch to defrost operation.</p> <p>During defrost operation, the indoor unit fan will stop operation, and the following icon will appear on the home screen:</p>  <p>The system will resume normal operation after approximately 6 to 8 minutes.</p>
Hot start	<p>During hot start, the indoor unit fan will stop operation, and the following icon will appear on the home screen:</p> 

8.2.3 Adjusting the airflow direction

The following airflow directions can be set:

Direction	Screen
Fixed position. The indoor unit blows air in 1 of 5 fixed positions.	
Swing. The indoor unit alternates between the 5 positions.	
Auto. The indoor unit adjusts its airflow direction according to movement sensed by a movement sensor.	

**INFORMATION**

Depending on system layout and organisation, Auto airflow direction may not be available.

**INFORMATION**

For setting procedure of the airflow direction, see the reference guide or the manual of the used user interface.

Automatic airflow control

Cooling	Heating
<ul style="list-style-type: none"> When the room temperature is lower than the controller's setpoint for cooling operation (including auto operation). When the indoor units run in Continuous operation, and the airflow direction is downward. 	<ul style="list-style-type: none"> When starting operation. When the room temperature is higher than the controller's setpoint for heating operation (including auto operation). At defrost operation.
<ul style="list-style-type: none"> When the indoor units run continuously for a long time and the airflow direction is Horizontal. 	

**WARNING**

NEVER touch the air outlet or the horizontal blades while the swing flap is in operation. Fingers may become caught or the unit may break down.

**NOTICE**

Avoid operating in the horizontal direction. It may cause dew or dust to settle on the ceiling or flap.

8.2.4 Active circulation airflow

Use active circulation airflow to heat or cool the room more quickly.

**INFORMATION**

For setting procedure of the active circulation airflow, see the reference guide or the manual of the used user interface.

8.3 To operate the system

**INFORMATION**

For setting of the operation mode, airflow direction, active circulation airflow or other settings, see the reference guide or operation manual of the user interface.

9 Energy saving and optimum operation



CAUTION

NEVER expose little children, plants or animals directly to the airflow.



NOTICE

Do NOT place objects that should NOT get wet below the unit. Condensation on the unit or refrigerant pipes, or drain blockage may cause dripping. **Possible consequence:** Objects under the unit can get dirty or damaged.



WARNING

Do NOT place a flammable spray bottle near the air conditioner and do NOT use sprays near the unit. Doing so may result in a fire.

Observe the following precautions to ensure the system operates properly.

- Prevent direct sunlight from entering a room during cooling operation by using curtains or blinds.
- Make sure the area is well ventilated. Do NOT block any ventilation openings.
- Ventilate often. Extended use requires special attention to ventilation.
- Keep doors and windows closed. If the doors and windows remain open, air will flow out of your room causing a decrease in the cooling or heating effect.
- Be careful NOT to cool or heat too much. To save energy, keep the temperature setting at a moderate level.
- NEVER place objects near the air inlet or the air outlet of the unit. Doing so may cause a reduced heating/cooling effect or stop operation.
- Turn off the main power supply switch to the unit when the unit is NOT used for longer periods of time. If the main power supply switch is on, the unit consumes electricity. Before restarting the unit, turn on the main power supply switch 6 hours before operation to ensure smooth running.
- When the display shows  (time to clean the air filter), clean the filters (see "10.2.1 To clean the air filter" [▶ 31]).
- Condensation may form if the humidity is above 80% or if the drain outlet gets blocked.
- Adjust the air outlet properly and avoid direct air flow to room inhabitants.

10 Maintenance and service

10.1 Precautions for maintenance and service

 **CAUTION**
See "4 User safety instructions" [▶ 18] to acknowledge all related safety instructions.

 **DANGER: RISK OF ELECTROCUTION**
Disconnect the power supply for more than 10 minutes, and measure the voltage at the terminals of main circuit capacitors or electrical components before servicing. The voltage **MUST** be less than 50 V DC before you can touch electrical components. For the location of the terminals, see the warning label for persons performing service and maintenance.

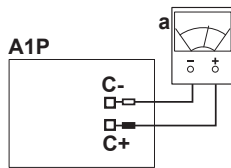

- A1P** Main printed circuit board
- a** Multimeter
- C** Residual voltage measuring points

 **NOTICE**
NEVER inspect or service the unit by yourself. Ask a qualified service person to perform this work. However, as end user, you may clean the air filter, suction grille, air outlet and outside panels.

 **NOTICE**
Maintenance **MUST** be done by an authorised installer or service agent. We recommend performing maintenance at least once a year. However, applicable legislation might require shorter maintenance intervals.

 **NOTICE**
Do **NOT** wipe the controller operation panel with benzine, thinner, chemical dust cloth, etc. The panel may get discoloured or the coating peeled off. If it is heavily dirty, soak a cloth in water-diluted neutral detergent, squeeze it well and wipe the panel clean. Wipe it with another dry cloth.

 **NOTICE**
When cleaning the heat exchanger, make sure to remove the switch box, fan motor, drain pump and float switch. Water or detergent might deteriorate the insulation of electronic components and result in burnout of these components.

Following symbols may occur on the indoor unit:

Symbol	Explanation
	Measure the voltage at the terminals of main circuit capacitors or electrical components before servicing.

10.2 Cleaning the air filter, suction grille, air outlet and outside panels



CAUTION

Turn off the unit before cleaning the air filter, suction grille, air outlet and outside panels.



NOTICE

- Do NOT use gasoline, benzene, thinner polishing powder or liquid insecticide. **Possible consequence:** Discoloration and deformation.
- Do NOT use water or air of 50°C or higher. **Possible consequence:** Discoloration and deformation.
- Do NOT scrub firmly when washing the blade with water. **Possible consequence:** The surface sealing peels off.

10.2.1 To clean the air filter

When to clean the air filter:

- Rule of thumb: Clean every 6 months. If the air in the room is extremely contaminated, increase the cleaning frequency.
- Depending on the settings, the user interface can display the "**Time to clean filter**" notification. Clean the air filter when the notification is displayed.
- If the dirt becomes impossible to clean, change the air filter (= optional equipment).

How to clean the air filter:

- 1 Open the suction grille.

Standard panel:

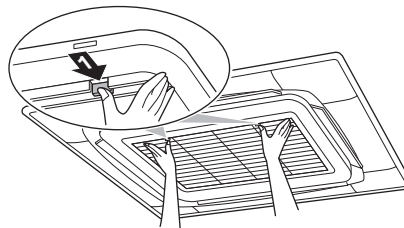

Design panel:

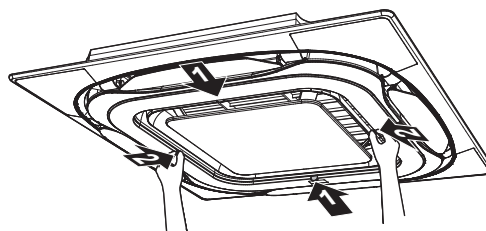

- 2 Remove the air filter.

Standard panel:

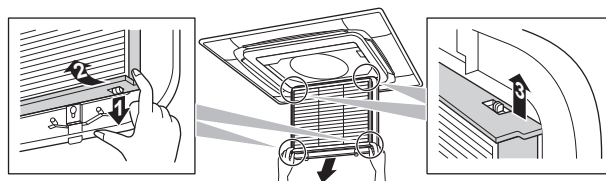

Design panel:

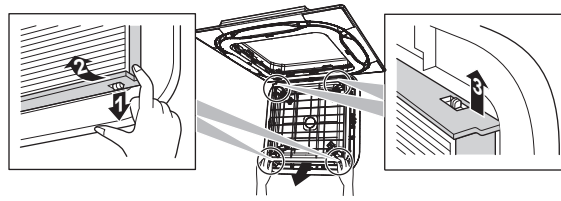

- 3 Clean the air filter. Use a vacuum cleaner or wash with water. If the air filter is very dirty, use a soft brush and neutral detergent.

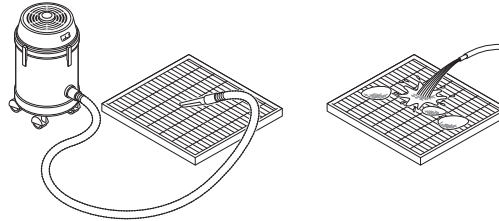

- 4 Dry the air filter in the shadow.
- 5 Reattach the air filter and close the suction grille.
- 6 Turn ON the power.
- 7 To remove warning screens, see the reference guide of the user interface.

10.2.2 To clean the suction grille



NOTICE

Do NOT use water of 50°C or higher. **Possible consequence:** Discoloration and deformation.

- 1 Open the suction grille.

Standard panel:

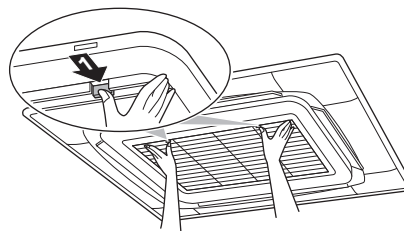

Design panel:

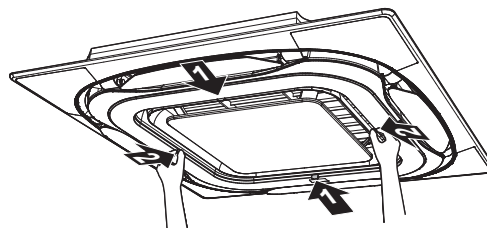

- 2 Remove the suction grille.

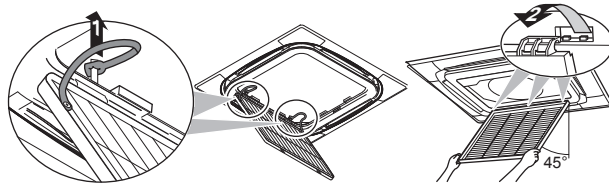
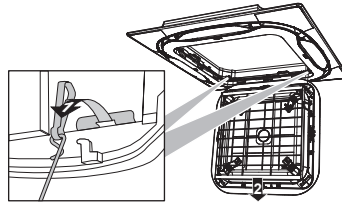
Standard panel:**Design panel:**

- 3 Remove the air filter.

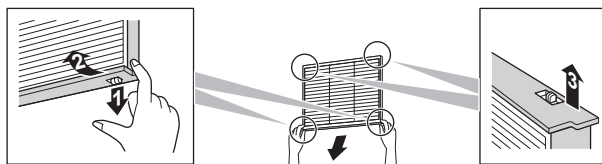

- 4 Clean the suction grille. Wash with a soft bristle brush, and water or neutral detergent. If the suction grille is very dirty, use a typical kitchen cleaner, leave it on for 10 min, then wash it with water.
- 5 Reattach the air filter (step 3 in reverse order).
- 6 Reattach the suction grille and close it (step 2 and 1 in reverse order).

10.2.3 To clean the air outlet and outside panels

**WARNING**

Do NOT let the indoor unit get wet. **Possible consequence:** Electrical shock or fire.

**NOTICE**

- Do NOT use gasoline, benzene, thinner polishing powder or liquid insecticide. **Possible consequence:** Discoloration and deformation.
- Do NOT use water or air of 50°C or higher. **Possible consequence:** Discoloration and deformation.
- Do NOT scrub firmly when washing the blade with water. **Possible consequence:** The surface sealing peels off.

Clean with a soft cloth. If it is difficult to remove stains, use water or neutral detergent.

10.3 Maintenance after a long stop period

- Check and remove everything that might be blocking inlet and outlet vents of indoor units and outdoor units.
- Clean air filters and casings of indoor units (see "10.2.1 To clean the air filter" [▶ 31] and "10.2.3 To clean the air outlet and outside panels" [▶ 33]).

10.4 Maintenance before a long stop period

- Let the indoor units run in fan only operation for about half a day in order to dry the interior of the units.
- Turn off the power. The user interface display disappears.
- Clean air filters and casings of indoor units (see "10.2.1 To clean the air filter" [▶ 31] and "10.2.3 To clean the air outlet and outside panels" [▶ 33]).

10.5 About the refrigerant

This product contains fluorinated greenhouse gases. Do NOT vent gases into the atmosphere.

Refrigerant type: R32

Global warming potential (GWP) value: 675

Refrigerant type: R410A

Global warming potential (GWP) value: 2087.5



NOTICE

Applicable legislation on **fluorinated greenhouse gases** requires that the refrigerant charge of the unit is indicated both in weight and CO₂ equivalent.

Formula to calculate the quantity in CO₂ equivalent tonnes: GWP value of the refrigerant × total refrigerant charge [in kg]/1000

Contact your installer for more information.



WARNING: MILDLY FLAMMABLE MATERIAL

The R32 refrigerant (if applicable) in this unit is mildly flammable. Refer to the outdoor unit specifications for the type of refrigerant to be used.



WARNING

The appliance using R32 refrigerant shall be stored so as to prevent mechanical damage and in a well-ventilated room without continuously operating ignition sources (e.g. open flames, an operating gas appliance, or an operating electric heater). The room size shall be as specified in the General safety precaution.



WARNING

- Do NOT pierce or burn refrigerant cycle parts.
- Do NOT use cleaning materials or means to accelerate the defrosting process other than those recommended by the manufacturer.
- Be aware that the refrigerant inside the system is odourless.



WARNING

- R410A is a non-combustible refrigerant, and R32 is a mildly flammable refrigerant; they normally do NOT leak. If the refrigerant leaks in the room and comes into contact with fire from a burner, a heater, or a cooker, this may result in a fire (in case of R32), or the formation of a harmful gas.
- Turn OFF any combustible heating devices, ventilate the room, and contact the dealer from where you purchased the unit.
- Do NOT use the unit until a service person confirms that the part from which the refrigerant leaked has been repaired.

11 Troubleshooting

If one of the following malfunctions occurs, take the measures shown below and contact your dealer.



WARNING

Stop operation and shut OFF the power if anything unusual occurs (burning smells etc.).

Leaving the unit running under such circumstances may cause breakage, electrical shock or fire. Contact your dealer.

The system **MUST** be repaired by a qualified service person.

Malfunction	Measure
If a safety device such as a fuse, a circuit breaker or a residual current device frequently actuates or the ON/OFF switch does NOT function properly.	Turn OFF all main power supply switches to the unit.
If water leaks from the unit.	Stop operation.
The operation switch does NOT function properly.	Turn OFF the power supply.
If the user interface displays  .	Notify your installer and report the error code. To display an error code see the reference guide of the user interface.

Malfunction	Measure
If the system does not operate at all.	<ul style="list-style-type: none"> ▪ Check if there is no power failure. Wait until power is restored. If power failure occurs during operation, the system automatically restarts immediately after power is restored. ▪ Check if no fuse has blown or breaker is activated. Change the fuse or reset the breaker if necessary.
The system operates but cooling or heating is insufficient.	<ul style="list-style-type: none"> ▪ Check if air inlet or outlet of outdoor or indoor unit is not blocked by obstacles. Remove any obstacles and make sure the air can flow freely. ▪ Check if the air filter is not clogged (see "10.2.1 To clean the air filter" [▶ 31]). ▪ Check the temperature setting. ▪ Check the fan speed setting on your user interface. ▪ Check for open doors or windows. Close doors and windows to prevent wind from coming in. ▪ Check if there are too many occupants in the room during cooling operation. Check if the heat source of the room is excessive. ▪ Check if direct sunlight enters the room. Use curtains or blinds. ▪ Check if the air flow angle is proper.

After checking all the items above, if it is impossible to fix the problem yourself, contact your installer and state the symptoms, the complete model name of the unit (with manufacturing number if possible) and the installation date.

11.1 Symptoms that are NOT system malfunctions

The following symptoms are NOT system malfunctions:

11.1.1 Symptom: The system does not operate

- The air conditioner does not start immediately after the ON/OFF button on the user interface is pressed. If the operation lamp lights, the system is in normal condition. To prevent overloading of the compressor motor, the air conditioner starts 5 minutes after it is turned ON again in case it was turned OFF just before. The same starting delay occurs after the operation mode selector button was used.
- If "Under Centralised Control" is displayed on the user interface, pressing the operation button causes the display to blink for a few seconds. The blinking display indicates that the user interface cannot be used.
- The system does not start immediately after the power supply is turned on. Wait one minute until the microcomputer is prepared for operation.

11.1.2 Symptom: The fan speed does not correspond to the setting

The fan speed does not change even if the fan speed adjustment button is pressed. During heating operation, when the room temperature reaches the set temperature, the outdoor unit goes off and the indoor unit changes to whisper fan speed. This is to prevent cold air blowing directly on occupants of the room. The fan speed will not change if the button is pressed.

11.1.3 Symptom: The fan direction does not correspond to the setting

The fan direction does not correspond with the user interface display. The fan direction does not swing. This is because the unit is being controlled by the micro computer.

11.1.4 Symptom: White mist comes out of a unit (Indoor unit)

- When humidity is high during cooling operation. If the interior of an indoor unit is extremely contaminated, the temperature distribution inside a room becomes uneven. It is necessary to clean the interior of the indoor unit. Ask your dealer for details on cleaning the unit. This operation requires a qualified service person.
- Immediately after the cooling operation stops and if the room temperature and humidity are low. This is because warm refrigerant gas flows back into the indoor unit and generates steam.

11.1.5 Symptom: White mist comes out of a unit (Indoor unit, outdoor unit)

When the system is changed over to heating operation after defrost operation. Moisture generated by defrost becomes steam and is exhausted.

11.1.6 Symptom: The user interface reads "U4" or "U5" and stops, but then restarts after a few minutes

This is because the user interface is intercepting noise from electric appliances other than the air conditioner. The noise prevents communication between the

units, causing them to stop. Operation automatically restarts when the noise ceases. A power reset may help to remove this error.

11.1.7 Symptom: Noise of air conditioners (Indoor unit)

- A continuous low "shah" sound is heard when the system is in cooling operation or at a stop. When the drain pump is in operation, this noise is heard.
- A "pishi-pishi" squeaking sound is heard when the system stops after heating operation. Expansion and contraction of plastic parts caused by temperature change make this noise.

11.1.8 Symptom: Noise of air conditioners (Indoor unit, outdoor unit)

- A continuous low hissing sound is heard when the system is in cooling or defrost operation. This is the sound of refrigerant gas flowing through both indoor and outdoor units.
- A hissing sound which is heard at the start or immediately after stopping operation or defrost operation. This is the noise of refrigerant caused by flow stop or flow change.

11.1.9 Symptom: Dust comes out of the unit

When the unit is used for the first time in a long time. This is because dust has gotten into the unit.

11.1.10 Symptom: The units can give off odours

The unit can absorb the smell of rooms, furniture, cigarettes, etc., and then emit it again.

12 Relocation

Contact your dealer to remove and reinstall the entire unit. Moving units requires technical expertise.

13 Disposal

**NOTICE**

Do NOT try to dismantle the system yourself: dismantling of the system, treatment of the refrigerant, oil and other parts **MUST** comply with applicable legislation. Units **MUST** be treated at a specialised treatment facility for reuse, recycling and recovery.

For the installer

14 About the box

Keep the following in mind:

- At delivery, the unit **MUST** be checked for damage and completeness. Any damage or missing parts **MUST** be reported immediately to the claims agent of the carrier.
- Bring the packed unit as close as possible to its final installation position to prevent damage during transport.
- Prepare in advance the path along which you want to bring the unit to its final installation position.
- When handling the unit, take into account the following:



Fragile, handle the unit with care.



Keep the unit upright in order to avoid damage.

14.1 Indoor unit



WARNING: MILDLY FLAMMABLE MATERIAL

The R32 refrigerant (if applicable) in this unit is mildly flammable. Refer to the outdoor unit specifications for the type of refrigerant to be used.

14.1.1 To unpack and handle the unit

Use a sling of soft material or protective plates together with a rope when lifting the unit in order to avoid damage or scratches to the unit.

- 1** Lift the unit by holding on to the hanger brackets without exerting any pressure on other parts, especially on refrigerant piping, drain piping and other resin parts.

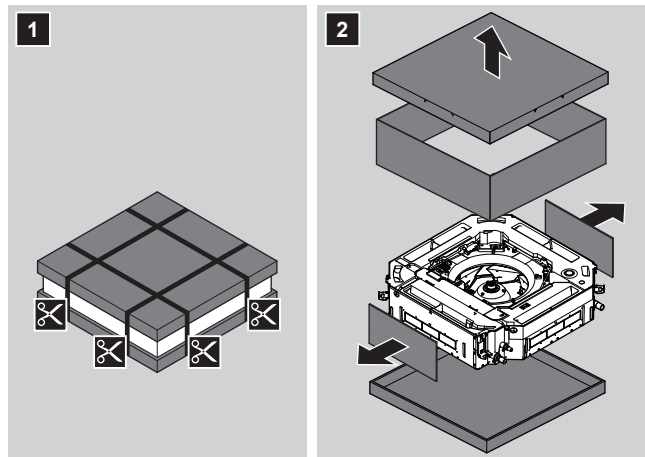

14.1.2 To remove the accessories from the indoor unit

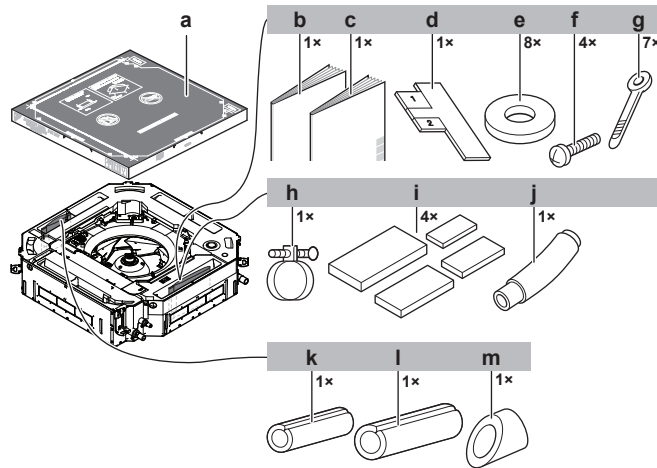

- a** Paper pattern for installation (upper part of packing)
- b** General safety precautions
- c** Indoor unit installation and operation manual
- d** Installation guide
- e** Washers for hanger brackets
- f** Screws (to temporarily attach the paper pattern for installation to the indoor unit)
- g** Cable ties
- h** Metal clamp
- i** Sealing pads: Large (drain pipe), medium 1 (gas pipe), medium 2 (liquid pipe), small (electrical wiring)
- j** Drain hose
- k** Insulation piece: Small (liquid pipe)
- l** Insulation piece: Large (gas pipe)
- m** Insulation piece (drain pipe)

15 About the units and options

In this chapter

15.1	Identification.....	43
15.1.1	Identification label: Indoor unit.....	43
15.2	About the indoor unit.....	43
15.3	System layout.....	43
15.4	Combining units and options.....	44
15.4.1	Possible options for the indoor unit.....	44

15.1 Identification



NOTICE

When installing or servicing several units at the same time, make sure NOT to switch the service panels between different models.

15.1.1 Identification label: Indoor unit

Location

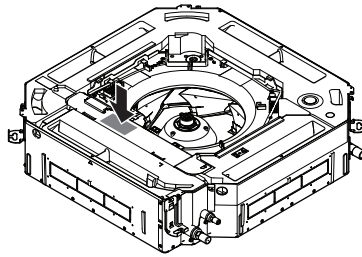

15.2 About the indoor unit



INFORMATION

For the operation limits see the technical data of the connected outdoor unit.

15.3 System layout



INFORMATION

The following figure is an example and may NOT completely match your system layout.

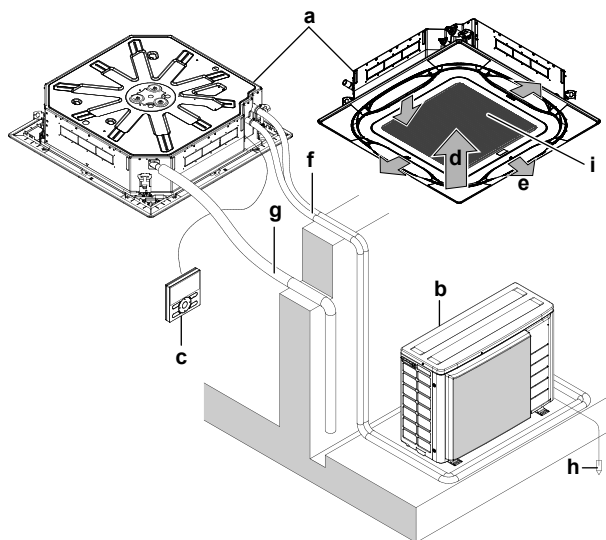

- a Indoor unit
- b Outdoor unit
- c User interface
- d Suction air
- e Discharge air
- f Refrigerant piping + interconnection cable
- g Drain pipe
- h Earth wiring
- i Suction grille and air filter

15.4 Combining units and options



INFORMATION

Certain options may NOT be available in your country.

15.4.1 Possible options for the indoor unit

Make sure you have the following mandatory options:

- User interface: Wired or wireless (refer to catalogues and technical literature for selecting a suitable user interface)
- Decoration panel: Standard, self-cleaning or design



INFORMATION

All possible options are mentioned in the option list of the indoor unit. For more information about an option, refer to the installation and operation manual of the option.

16 Unit installation

In this chapter

16.1	Preparing the installation site	45
16.1.1	Installation site requirements of the indoor unit.....	45
16.2	Mounting the indoor unit.....	48
16.2.1	Guidelines when installing the indoor unit.....	48
16.2.2	Guidelines when installing the drain piping	50

16.1 Preparing the installation site



WARNING

The appliance using R32 refrigerant shall be stored so as to prevent mechanical damage and in a well-ventilated room without continuously operating ignition sources (e.g. open flames, an operating gas appliance, or an operating electric heater). The room size shall be as specified in the General safety precaution.

Choose an installation location with sufficient space to transport the unit in and out of the site.

Do NOT install the unit in places often used as work place. In case of construction works (e.g. grinding works) where a lot of dust is created, the unit MUST be covered.

16.1.1 Installation site requirements of the indoor unit



INFORMATION

Also read the following requirements:

- General installation site requirements. See the "General safety precautions" chapter.
- Refrigerant piping requirements (length, height difference). See further in this "Preparation" chapter.



INFORMATION

The sound pressure level is less than 70 dBA.



CAUTION

Appliance NOT accessible to the general public, install it in a secured area, protected from easy access.

This unit, both indoor and outdoor, is suitable for installation in a commercial and light industrial environment.

Do NOT install the unit in the following places:

- In places where a mineral oil mist, spray or vapour may be present in the atmosphere. Plastic parts may deteriorate and fall off or cause water leakage.

It is NOT recommended to install the unit in the following places because it may shorten the life of the unit:

- Where the voltage fluctuates a lot
- In vehicles or vessels
- Where acidic or alkaline vapour is present

**NOTICE**

The equipment described in this manual may cause electronic noise generated from radio-frequency energy. The equipment complies with specifications that are designed to provide reasonable protection against such interference. However, there is no guarantee that interference will not occur in a particular installation.

It is therefore recommended to install the equipment and electric wires in such a way that they keep a proper distance from stereo equipment, personal computers, etc.

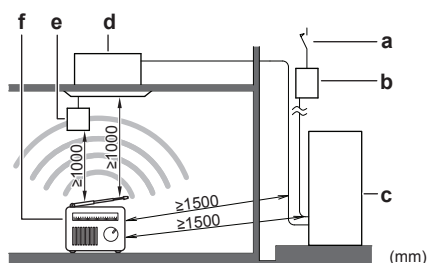

- a Earth leakage protector
- b Fuse
- c Outdoor unit
- d Indoor unit
- e User interface
- f Personal computer or radio

- In places with weak reception, keep distances of 3 m or more to avoid electromagnetic disturbance of other equipment and use conduit tubes for power and transmission lines.
- **Fluorescent lights.** When installing a wireless remote control (user interface) in a room with fluorescent lights, mind the following to avoid interference:
 - Install the wireless remote control (user interface) as close as possible to the indoor unit.
 - Install the indoor unit as far as possible from the fluorescent lights.
- Ensure that in the event of a water leak, no damage occurs to the installation space or its surroundings.
- Choose a location where the operation noise or the hot/cold air discharged from the unit will not disturb anyone and the location is selected according the applicable legislation.
- **Air flow.** Make sure nothing blocks the air flow.
- **Drainage.** Make sure condensation water can be evacuated properly.
- **Paper pattern for installation** (upper part of packing) (accessory). When selecting the installation location, use the paper pattern. It contains the dimensions of the unit and the required ceiling opening.
- **Air flow directions.** You can select different air flow directions. Choose the one best suited for the room. For more information, see the installation manual of the optional blocking pad kit.

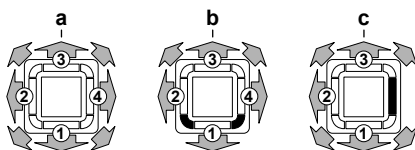
Example:

- a All-round air flow
- b 4-way air flow (with closed corners) (optional blocking pad kit required)
- c 3-way air flow (optional blocking pad kit required)

- **Ceiling insulation.** When conditions in the ceiling exceed 30°C and a relative humidity of 80%, or when fresh air is inducted into the ceiling, then additional insulation is required (minimum 10 mm thickness, polyethylene foam).
- **Spacing.** Mind the following requirements:

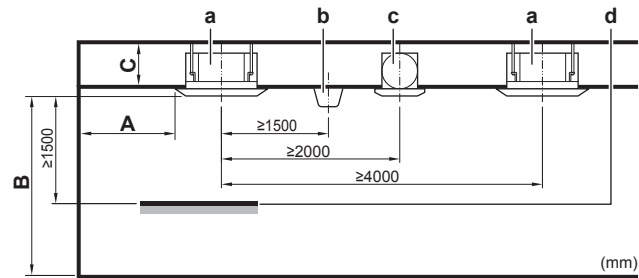

A Minimum distance to the wall (see below)

B Minimum and maximum distance to the floor (see below)

C 35~71 class:

≥227 mm: In case of installation with standard panel

≥269 mm: In case of installation with design panel

≥307 mm: In case of installation with self-cleaning panel

≥277 mm: In case of installation with standard panel + fresh air intake kit

≥319 mm: In case of installation with design panel + fresh air intake kit

100~140 class:

≥269 mm: In case of installation with standard panel

≥311 mm: In case of installation with design panel

≥349 mm: In case of installation with self-cleaning panel

≥319 mm: In case of installation with standard panel + fresh air intake kit

≥361 mm: In case of installation with design panel + fresh air intake kit

a Indoor unit

b Lighting (the figure shows ceiling-mounted lighting, but recessed lighting is also allowed)

c Air fan

d Static volume (example: table)

- **A: Minimum distance to the wall.** Depends on the airflow directions towards the wall.

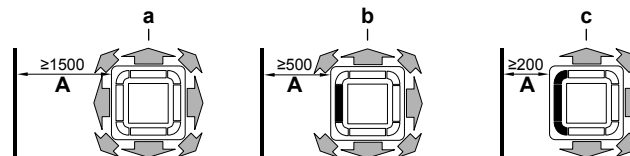

a Air outlet and corners open

b Air outlet closed, corners open (optional blocking pad kit required)

c Air outlet and corners closed (optional blocking pad kit required)

- **B: Minimum and maximum distance to the floor:**

- Minimum: 2.5 m to avoid accidental touching.

- Maximum: Depends on the airflow directions and the capacity class. See "20.1 Field setting" [▶ 68].



INFORMATION

Maximum distance to the floor for the 3-way and the 4-way airflow (which require an optional blocking pad kit) may differ. See the installation manual of the optional blocking pad kit.

16.2 Mounting the indoor unit

16.2.1 Guidelines when installing the indoor unit



INFORMATION

Optional equipment. When installing optional equipment, also read the installation manual of the optional equipment. Depending on the field conditions, it might be easier to install the optional equipment first.

- **In case of installation with a fresh air intake kit.** Install the fresh air intake kit always **before** installing the unit.
- **Decoration panel.** Install the decoration panel always **after** installing the unit.



NOTICE

After installing the decoration panel:

- Make sure there is no gap between the unit body and the decoration panel. **Possible consequence:** Air might leak and cause dew drop.
 - Make sure no oil remains on the plastic parts of the decoration panel. **Possible consequence:** Degradation and damage of plastic parts.
- **Ceiling strength.** Check whether the ceiling is strong enough to support the weight of the unit. If there is a risk, reinforce the ceiling before installing the unit.
 - For existing ceilings, use anchors.
 - For new ceilings, use sunken inserts, sunken anchors or other field supplied parts.

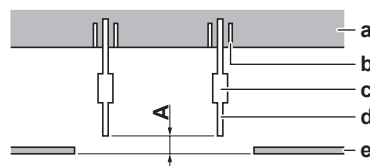

- A** 50~100 mm: In case of installation with standard panel
 100~150 mm: In case of installation with fresh air intake kit or design panel
 130~180 mm: In case of installation with auto cleaning decoration panel
- a** Ceiling slab
 - b** Anchor
 - c** Long nut or turnbuckle
 - d** Suspension bolt
 - e** Suspended ceiling

- **Suspension bolts.** Use M8~M10 suspension bolts for installation. Attach the hanger bracket to the suspension bolt. Fix it securely using a nut and washer from the upper and lower sides of the hanger bracket.

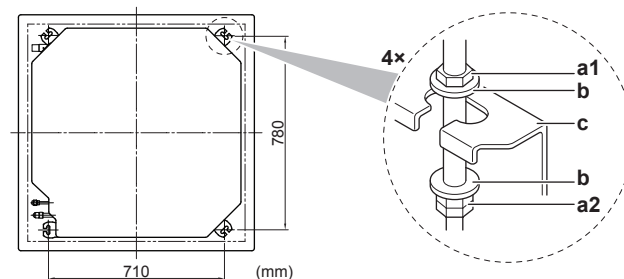

- a1** Nut (field supply)
- a2** Double nut (field supply)
- b** Washer (accessories)
- c** Hanger bracket (attached to the unit)

- **Paper pattern for installation** (upper part of the packing). Use the paper pattern to determine the correct horizontal positioning. It contains the necessary dimensions and centers. You can attach the paper pattern to the unit.

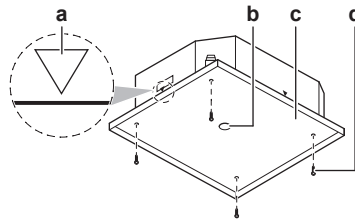

- a Centre of the unit
- b Centre of the ceiling opening
- c Paper pattern for installation (upper part of the packing)
- d Screws (accessories)

- **Ceiling opening and unit:**

- Make sure the ceiling opening is within the following limits:

Minimum: 860 mm to be able to fit the unit.

Maximum: 910 mm to ensure enough overlap between the decoration panel and the suspended ceiling. If the ceiling opening is larger, add extra ceiling material.

- Make sure the unit and its hanger brackets (suspension) are centered within the ceiling opening.

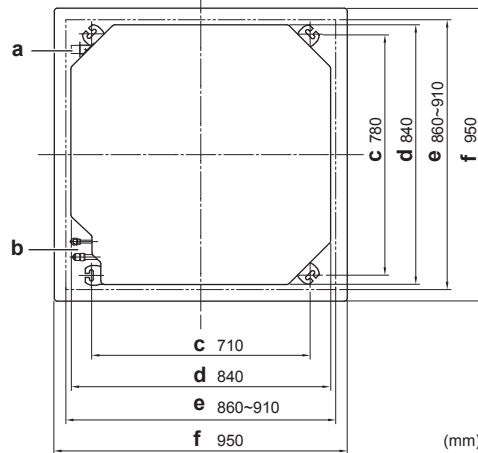

- a Drain piping
- b Refrigerant piping
- c Hanger bracket pitch (suspension)
- d Unit
- e Ceiling opening
- f Decoration panel

Example	If A ^(a)	Then	
		B ^(a)	C ^(a)
	860 mm	10 mm	45 mm
	910 mm	35 mm	20 mm

- ^(a) **A:** Ceiling opening
- B:** Distance between the unit and the ceiling opening
- C:** Overlap between the decoration panel and the suspended ceiling

- **Installation guide.** Use the installation guide to determine the correct vertical position.

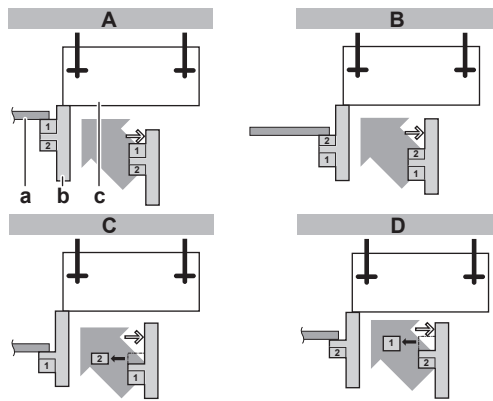

- A** In case of installation with standard decoration panel
- B** In case of installation with fresh air intake kit
- C** In case of installation with auto cleaning decoration panel
- D** In case of installation with design decoration panel
- a** Suspended ceiling
- b** Installation guide (accessory)
- c** Unit

- **Level.** Make sure the unit is level at all 4 corners using a level or a water-filled vinyl tube.

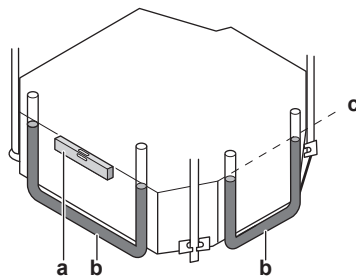

- a** Level
- b** Vinyl tube
- c** Water level



NOTICE

Do NOT install the unit tilted. **Possible consequence:** If the unit is tilted against the direction of the condensate flow (the drain piping side is raised), the float switch might malfunction and cause water to drip.

16.2.2 Guidelines when installing the drain piping

Make sure condensation water can be evacuated properly. This involves:

- General guidelines
- Connecting the drain piping to the indoor unit
- Checking for water leaks

General guidelines

- **Pipe length.** Keep drain piping as short as possible.
- **Pipe size.** Keep the pipe size equal to or greater than that of the connecting pipe (vinyl pipe of 25 mm nominal diameter and 32 mm outer diameter).
- **Slope.** Make sure the drain piping slopes down (at least 1/100) to prevent air from being trapped in the piping. Use hanging bars as shown.

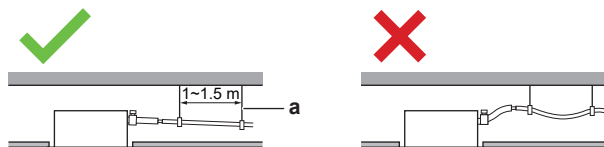

- a** Hanging bar
- ✓ Allowed
- ✗ Not allowed

- **Rising piping.** If necessary to make the slope possible, you can install rising piping.
 - Drain hose inclination: 0~75 mm to avoid stress on the piping and to avoid air bubbles.
 - Rising piping: ≤300 mm from the unit, ≤675 mm perpendicular to the unit.
- **Condensation.** Take measures against condensation. Insulate the complete drain piping in the building.
- **Combining drain pipes.** You can combine drain pipes. Make sure to use drain pipes and T-joints with a correct gauge for the operating capacity of the units.

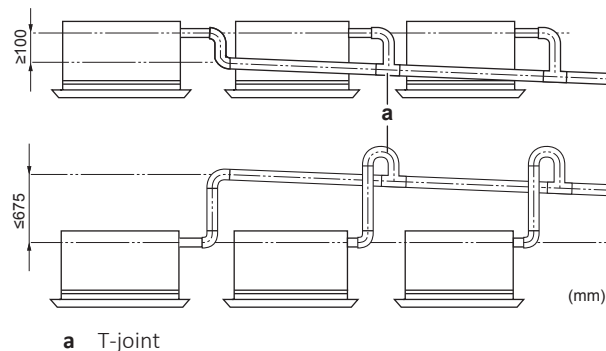

To connect the drain piping to the indoor unit



NOTICE

Incorrect connection of the drain hose might cause leaks, and damage the installation space and surroundings.

- 1 Push the drain hose as far as possible over the drain pipe connection.
- 2 Tighten the metal clamp until the screw head is less than 4 mm from the metal clamp part.
- 3 Check for water leaks (see "[To check for water leaks](#)" [▶ 52]).
- 4 Install the insulation piece (drain pipe).
- 5 Wind the large sealing pad (= insulation) around the metal clamp and drain hose, and fix it with tie wraps.
- 6 Connect the drain piping to the drain hose.

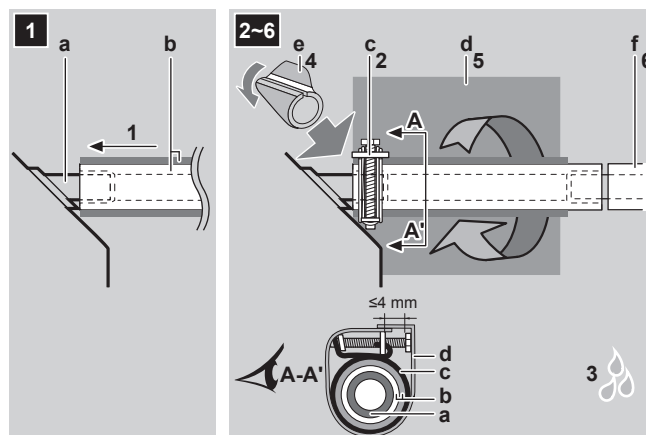

- a** Drain pipe connection (attached to the unit)
- b** Drain hose (accessory)
- c** Metal clamp (accessory)

- d** Large sealing pad (accessory)
- e** Insulation piece (drain pipe) (accessory)
- f** Drain piping (field supply)

To check for water leaks

The procedure differs depending on whether electrical wiring is already finished. When electrical wiring is not finished yet, you need to temporarily connect the user interface and power supply to the unit.

When installation of the system is not yet completed

- 1** Temporarily connect electrical wiring.
 - Remove the service cover.
 - Connect the user interface.
 - Connect the power supply.
 - Reattach the service cover.

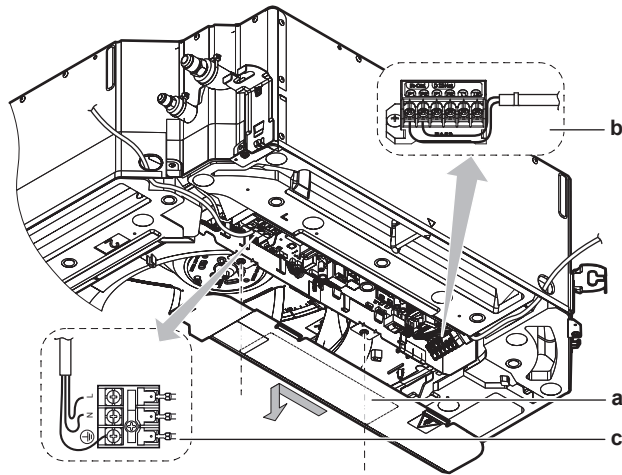

- a** Service cover with wiring diagram
- b** User interface terminal block
- c** Power supply terminal block

- 2** Turn ON the power.
- 3** Start fan only operation (see the reference guide or the service manual of the user interface).
- 4** Gradually pour approximately 1 l of water through the air discharge outlet, and check for leaks.

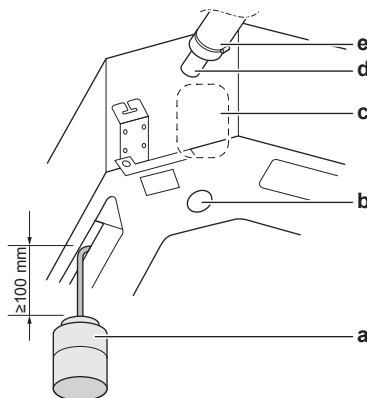

- a** Plastic watering can
- b** Service drain outlet (with rubber plug). Use this outlet to drain water from the drain pan
- c** Drain pump location
- d** Drain pipe connection
- e** Drain pipe

- 5** Turn OFF the power.

- 6 Disconnect the electrical wiring.
 - Remove the service cover.
 - Disconnect the power supply.
 - Disconnect the user interface.
 - Reattach the service cover.

When installation of the system is already completed

- 1 Start cooling operation (see the reference guide or the service manual of the user interface).
- 2 Gradually pour approximately 1 l of water through the water inlet, and check for leaks (see "[When installation of the system is not yet completed](#)" [▶ 52]).

17 Piping installation

In this chapter

17.1	Preparing refrigerant piping.....	54
17.1.1	Refrigerant piping requirements.....	54
17.1.2	Refrigerant piping insulation.....	55
17.2	Connecting the refrigerant piping.....	55
17.2.1	About connecting the refrigerant piping.....	55
17.2.2	Precautions when connecting the refrigerant piping.....	56
17.2.3	Guidelines when connecting the refrigerant piping.....	57
17.2.4	Pipe bending guidelines.....	57
17.2.5	To flare the pipe end.....	57
17.2.6	To connect the refrigerant piping to the indoor unit.....	58

17.1 Preparing refrigerant piping

17.1.1 Refrigerant piping requirements



CAUTION

Piping **MUST** be installed according to instructions given in "[17 Piping installation](#)" [▶ 54]. Only mechanical joints (e.g. braze+flare connections) that are compliant with the latest version of ISO14903 can be used.



NOTICE

The piping and other pressure-containing parts shall be suitable for refrigerant. Use phosphoric acid deoxidised seamless copper for refrigerant piping.



INFORMATION

Also read the precautions and requirements in the "[2 General safety precautions](#)" [▶ 7].

- Foreign materials inside pipes (including oils for fabrication) must be ≤30 mg/10 m.

Refrigerant piping diameter

Use the same diameters as the connections on the outdoor units:

Model	L1 liquid piping	L1 gas piping
FCAG35	Ø6.4	Ø9.5
FCAG50~60	Ø6.4	Ø12.7
FCAG71~140	Ø9.5	Ø15.9

Refrigerant piping material

Piping material

Phosphoric acid deoxidised seamless copper

Flare connections

Only use annealed material.

Piping temper grade and thickness

Outer diameter (ϕ)	Temper grade	Thickness (t) ^(a)	
6.4 mm (1/4")	Annealed (O)	≥ 0.8 mm	
9.5 mm (3/8")			
12.7 mm (1/2")			
15.9 mm (5/8")			

^(a) Depending on the applicable legislation and the maximum working pressure of the unit (see "PS High" on the unit name plate), larger piping thickness might be required.

17.1.2 Refrigerant piping insulation

- Use polyethylene foam as insulation material:
 - with a heat transfer rate between 0.041 and 0.052 W/mK (0.035 and 0.045 kcal/mh°C)
 - with a heat resistance of at least 120°C
- Insulation thickness:

Pipe outer diameter (ϕ_p)	Insulation inner diameter (ϕ_i)	Insulation thickness (t)
6.4 mm (1/4")	8~10 mm	≥ 10 mm
9.5 mm (3/8")	12~15 mm	≥ 13 mm
12.7 mm (1/2")	14~16 mm	≥ 13 mm
15.9 mm (5/8")	17~20 mm	≥ 13 mm

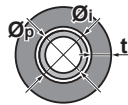

If the temperature is higher than 30°C and the humidity is higher than RH 80%, the thickness of the insulation materials should be at least 20 mm to prevent condensation on the surface of the insulation.

17.2 Connecting the refrigerant piping

17.2.1 About connecting the refrigerant piping

Before connecting the refrigerant piping

Make sure the outdoor and indoor unit are mounted.

Typical workflow

Connecting the refrigerant piping involves:

- Connecting the refrigerant piping to the indoor unit
- Connecting the refrigerant piping to the outdoor unit
- Insulating the refrigerant piping
- Keeping in mind the guidelines for:
 - Pipe bending
 - Flaring pipe ends
 - Using the stop valves

17.2.2 Precautions when connecting the refrigerant piping

i **INFORMATION**
 Also read the precautions and requirements in the following chapters:

- "2 General safety precautions" [▶ 7]
- "17.1 Preparing refrigerant piping" [▶ 54]

SSS **DANGER: RISK OF BURNING/SCALDING**

! **NOTICE**

- Do NOT use mineral oil on flared part.
- NEVER install a drier to this unit to guarantee its lifetime. The drying material may dissolve and damage the system.
- Use the flare nut fixed to the main unit.
- To prevent gas leakage, apply refrigeration oil only to the inside of the flare. Use refrigeration oil for R32/R410A.
- Do NOT reuse joints.

! **NOTICE**

Take the following precautions on refrigerant piping into account:

- Avoid anything but the designated refrigerant to get mixed into the refrigerant cycle (e.g. air).
- Only use R32 or R410A when adding refrigerant. Refer to the outdoor unit specifications for the type of refrigerant to be used.
- Only use installation tools (e.g. manifold gauge set) that are exclusively used for R32 or R410A installations to withstand the pressure and to prevent foreign materials (e.g. mineral oils and moisture) from mixing into the system.
- Install the piping so that the flare is NOT subjected to mechanical stress.
- Do NOT leave pipes unattended at the site. If the installation is NOT done within 1 day, protect the piping as described in the following table to prevent dirt, liquid or dust from entering the piping.
- Use caution when passing copper tubes through walls (see figure below).

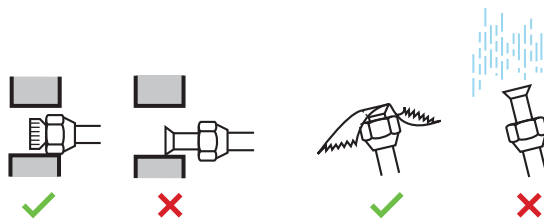

Unit	Installation period	Protection method
Outdoor unit	>1 month	Pinch the pipe
	<1 month	Pinch or tape the pipe
Indoor unit	Regardless of the period	

! **NOTICE**

Do NOT open the refrigerant stop valve before checking the refrigerant piping. When you need to charge additional refrigerant it is recommended to open the refrigerant stop valve after charging.

17.2.3 Guidelines when connecting the refrigerant piping

Take the following guidelines into account when connecting pipes:

- Coat the flare inner surface with ether oil or ester oil when connecting a flare nut. Tighten 3 or 4 turns by hand, before tightening firmly.

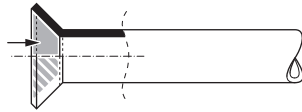

- ALWAYS use 2 wrenches together when loosening a flare nut.
- ALWAYS use a spanner and torque wrench together to tighten the flare nut when connecting the piping. This to prevent nut cracking and leaks.

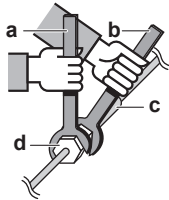

- a Torque wrench
- b Spanner
- c Piping union
- d Flare nut

Piping size (mm)	Tightening torque (N•m)	Flare dimensions (A) (mm)	Flare shape (mm)
∅6.4	15~17	8.7~9.1	
∅9.5	33~39	12.8~13.2	
∅12.7	50~60	16.2~16.6	
∅15.9	62~75	19.3~19.7	

17.2.4 Pipe bending guidelines

Use a pipe bender for bending. All pipe bends should be as gentle as possible (bending radius should be 30~40 mm or larger).

17.2.5 To flare the pipe end

CAUTION

- Incomplete flaring may cause refrigerant gas leakage.
- Do NOT re-use flares. Use new flares to prevent refrigerant gas leakage.
- Use flare nuts that are included with the unit. Using different flare nuts may cause refrigerant gas leakage.

- 1 Cut the pipe end with a pipe cutter.
- 2 Remove burrs with the cut surface facing down so that the chips do NOT enter the pipe.

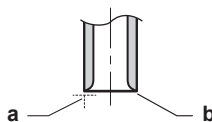

- a Cut exactly at right angles.
- b Remove burrs.

- 3 Remove the flare nut from the stop valve and put the flare nut on the pipe.
- 4 Flare the pipe. Set exactly at the position as shown in the following figure.

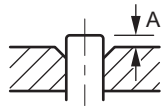

	Flare tool for R410A or R32 (clutch type)	Conventional flare tool	
		Clutch type (Rigid-type)	Wing nut type (Imperial-type)
A	0~0.5 mm	1.0~1.5 mm	1.5~2.0 mm

5 Check that the flaring is properly made.

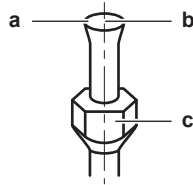

- a Flare's inner surface MUST be flawless.
- b The pipe end MUST be evenly flared in a perfect circle.
- c Make sure the flare nut is fitted.

17.2.6 To connect the refrigerant piping to the indoor unit

CAUTION

Install the refrigerant piping or components in a position where they are unlikely to be exposed to any substance which may corrode components containing refrigerant, unless the components are constructed of materials that are inherently resistant to corrosion or are suitably protected against corrosion.

WARNING: MILDLY FLAMMABLE MATERIAL

The R32 refrigerant (if applicable) in this unit is mildly flammable. Refer to the outdoor unit specifications for the type of refrigerant to be used.

- **Pipe length.** Keep refrigerant piping as short as possible.
- **Flare connections.** Connect refrigerant piping to the unit using flare connections.
- **Insulation.** Insulate the refrigerant piping on the indoor unit as follows:

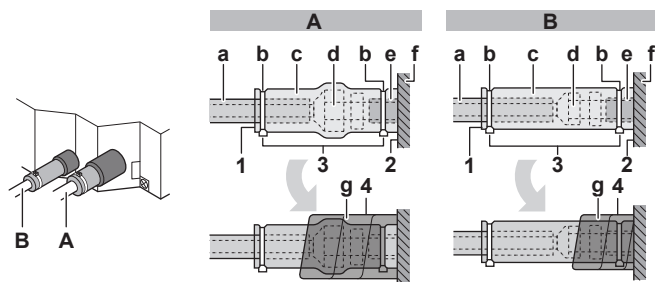

- A Gas piping
- B Liquid piping
- a Insulation material (field supply)
- b Tie wrap (accessory)
- c Insulation pieces: Large (gas pipe), small (liquid pipe) (accessories)
- d Flare nut (attached to the unit)
- e Refrigerant pipe connection (attached to the unit)
- f Unit
- g Sealing pads: Medium 1 (gas pipe), medium 2 (liquid pipe) (accessories)
- 1 Turn up the seams of the insulation pieces.
- 2 Attach to the base of the unit.
- 3 Tighten the tie wraps on the insulation pieces.
- 4 Wrap the sealing pad from the base of the unit to the top of the flare nut.

**NOTICE**

Make sure to insulate all refrigerant piping. Any exposed piping might cause condensation.

18 Electrical installation

In this chapter

18.1	About connecting the electrical wiring	60
18.1.1	Precautions when connecting the electrical wiring	60
18.1.2	Guidelines when connecting the electrical wiring	61
18.1.3	Specifications of standard wiring components	62
18.2	To connect the electrical wiring to the indoor unit	63

18.1 About connecting the electrical wiring

Typical workflow

Connecting the electrical wiring typically consists of the following stages:

- 1 Making sure the power supply system complies with the electrical specifications of the units.
- 2 Connecting the electrical wiring to the outdoor unit.
- 3 Connecting the electrical wiring to the indoor unit.
- 4 Connecting the main power supply.

18.1.1 Precautions when connecting the electrical wiring



DANGER: RISK OF ELECTROCUTION



WARNING

- All wiring **MUST** be performed by an authorised electrician and **MUST** comply with the national wiring regulation.
- Make electrical connections to the fixed wiring.
- All components procured on-site and all electrical construction **MUST** comply with the applicable legislation.



WARNING

ALWAYS use multicore cable for power supply cables.



INFORMATION

Also read the precautions and requirements in the "[2 General safety precautions](#)" [[▶ 7](#)].



INFORMATION

Also read "[18.1.3 Specifications of standard wiring components](#)" [[▶ 62](#)].

**WARNING**

- If the power supply has a missing or wrong N-phase, equipment might break down.
- Establish proper earthing. Do NOT earth the unit to a utility pipe, surge absorber, or telephone earth. Incomplete earthing may cause electrical shocks.
- Install the required fuses or circuit breakers.
- Secure the electrical wiring with cable ties so that the cables do NOT come in contact with sharp edges or piping, particularly on the high-pressure side.
- Do NOT install a phase advancing capacitor, because this unit is equipped with an inverter. A phase advancing capacitor will reduce performance and may cause accidents.

**WARNING**

Use an all-pole disconnection type breaker with at least 3 mm between the contact point gaps that provides full disconnection under overvoltage category III.

**WARNING**

If the supply cord is damaged, it MUST be replaced by the manufacturer, its service agent or similarly qualified persons in order to avoid a hazard.

18.1.2 Guidelines when connecting the electrical wiring

**NOTICE**

We recommend using solid (single-core) wires. If stranded wires are used, slightly twist the strands to consolidate the end of the conductor for either direct use in the terminal clamp or insertion in a round crimp-style terminal.

To prepare stranded conductor wire for installation**Method 1: Twisting conductor**

- 1 Strip insulation (20 mm) from the wires.
- 2 Slightly twist the end of the conductor to create a "solid-like" connection.

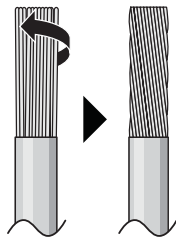
**Method 2: Using round crimp-style terminal (recommended)**

- 1 Strip insulation from wires and slightly twist the end of each wire.
- 2 Install a round crimp-style terminal on the end of the wire. Place the round crimp-style terminal on the wire up to the covered part and fasten the terminal with the appropriate tool.

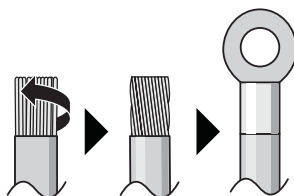

Use the following methods for installing wires:

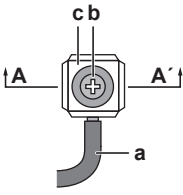
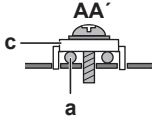
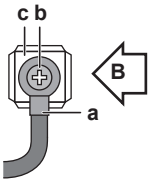
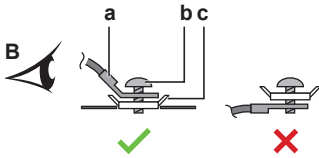
Wire type	Installation method
Single-core wire Or Stranded conductor wire twisted to "solid-like" connection	  <p>a Curled wire (single-core or twisted stranded conductor wire) b Screw c Flat washer</p>
Stranded conductor wire with round crimp-style terminal	  <p>a Terminal b Screw c Flat washer ✓ Allowed ✗ NOT allowed</p>

Tightening torques

Wiring	Screw size	Tightening torque (N•m)
Interconnection cable (indoor↔outdoor)	M4	1.18~1.44
User interface cable	M3.5	0.79~0.97

- The earth wire between the wire retainer and the terminal must be longer than the other wires.

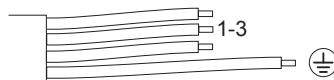

18.1.3 Specifications of standard wiring components

Component	Specification
Interconnection cable (indoor↔outdoor)	Only use harmonized wire providing double insulation and suitable for applicable voltage 4-core cable Minimum size 1.5 mm ²
User interface cable	Only use harmonized wire providing double insulation and suitable for applicable voltage 2-core cable Minimum size 0.75 mm ² Maximum length 500 m

18.2 To connect the electrical wiring to the indoor unit



WARNING

Do NOT extend the power supply or the interconnection cable by using wire connectors, wire connection clamps, taped wires, extension cords. These can cause overheating, electric shock or fire.



NOTICE

- Follow the wiring diagram (delivered with the unit, located at the inside of the service cover).
- For instructions on how to connect the decoration panel and the sensor kit, see the installation manual delivered with the panel or the kit.
- Make sure the electrical wiring does NOT obstruct proper reattachment of the service cover.

It is important to keep the power supply and the interconnection wiring separated from each other. In order to avoid any electrical interference, the distance between both wirings should ALWAYS be at least 50 mm.



NOTICE

Be sure to keep the power line and interconnection line apart from each other. Interconnection wiring and power supply wiring may cross, but may NOT run parallel.

- 1 Remove the service cover.
- 2 **User interface cable:** Route the cable through the frame, connect the cable to the terminal block, and fix the cable with a cable tie.
- 3 **Interconnection cable** (indoor↔outdoor): Route the cable through the frame, connect the cable to the terminal block (make sure the numbers match with the numbers on the outdoor unit, and connect the earth wire), and fix the cable with a cable tie.

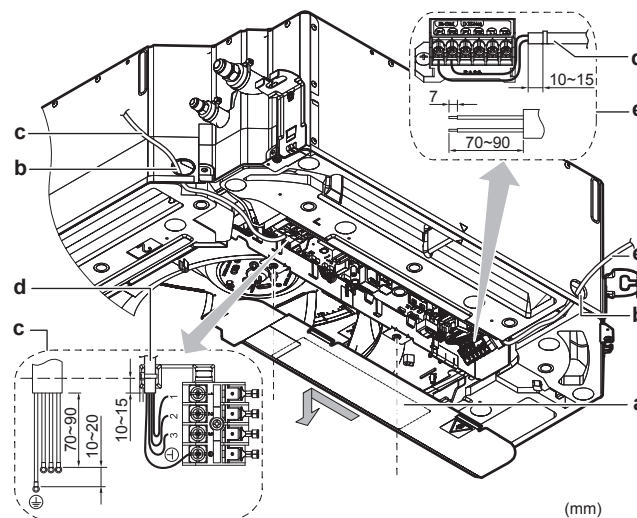

- a Service cover (with wiring diagram on the back)
- b Opening for cables
- c Connection of interconnection cable (including earth)
- d Cable tie
- e Connection of user interface cable

- 4 Divide the small sealing (accessory) and wrap it around the cables to prevent water from entering the unit. Seal all gaps to prevent small animals from entering the system.

**WARNING**

Provide adequate measures to prevent that the unit can be used as a shelter by small animals. Small animals that make contact with electrical parts can cause malfunctions, smoke or fire.

5 Reattach the service cover.

Complete system wiring example

For the wiring of outdoor units, refer to the installation manual attached to the outdoor units.

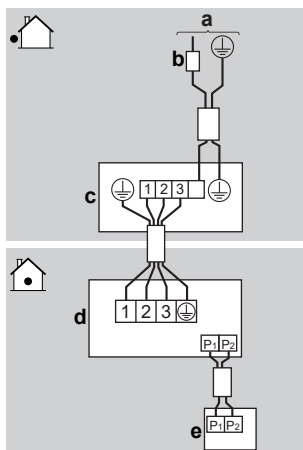
Pair type: 1 remote controller controls 1 indoor unit (standard)

- a Power supply
- b Residual current device
- c Outdoor unit
- d Indoor unit
- e User interface

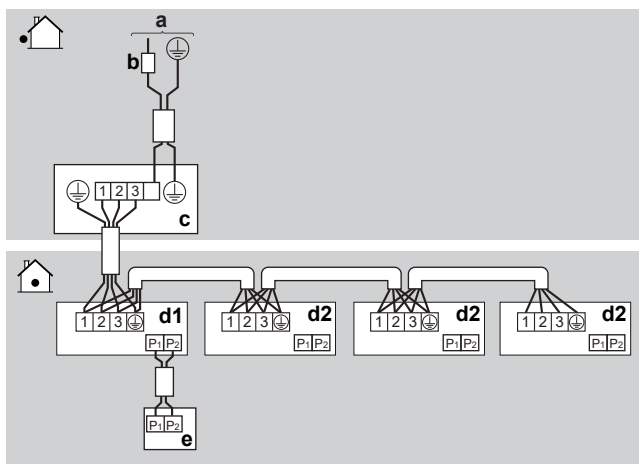
Simultaneous operation system: 1 user interface controls up to 4 indoor units in 1 pair system (all indoor units operates equally)

- a Power supply
- b Residual current device
- c Outdoor unit
- d1 Indoor unit (master)
- d2 Indoor unit (slave)
- e User interface

Connect the remote controller only to the master indoor unit. The thermistor reading of room temperature is effective only for the indoor unit connected to the user interface.

Refer to "20.1 Field setting" [▶ 68] for following settings:

- Number of the connected indoor units as simultaneous operation system
- Simultaneous operation system individual setting

Group control: 1 user interface controls up to 4 pair systems (all indoor units operate according to the user interface)

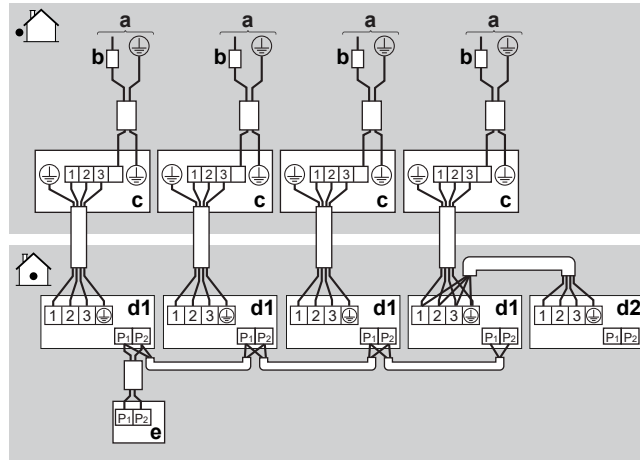

- a Power supply
- b Residual current device
- c Outdoor unit
- d1 Indoor unit (master)
- d2 Indoor unit (slave)
- e User interface

- You may control up to 16 units with 1 remote controller (combination of simultaneous operation and group control)
- All indoor units operate according to the user interface
- The thermistor reading of room temperature is effective only for the indoor unit connected to the user interface.

Control with 2 user interfaces: 2 user interfaces control 1 indoor unit

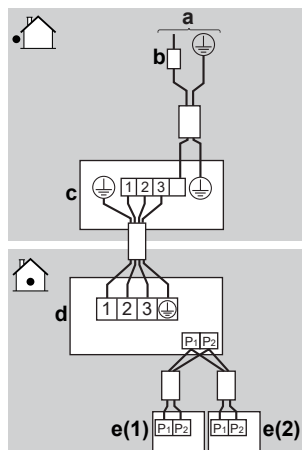

- a Power supply
- b Residual current device
- c Outdoor unit
- d Indoor unit
- e1 User interface (main)
- e2 User interface (sub)



INFORMATION

When using 2 user interfaces, one must be set to "MAIN" and the other to "SUB". For setting refer to the installation manual of the connected user interface.

19 Commissioning



NOTICE

General commissioning checklist. Next to the commissioning instructions in this chapter, a general commissioning checklist is also available on the Daikin Business Portal (authentication required).

The general commissioning checklist is complementary to the instructions in this chapter and can be used as a guideline and reporting template during commissioning and hand-over to the user.

In this chapter

19.1	Overview: Commissioning.....	66
19.2	Precautions when commissioning.....	66
19.3	Checklist before commissioning.....	67
19.4	To perform a test run.....	67

19.1 Overview: Commissioning

This chapter describes what you have to do and know to commission the system after it is installed.

Typical workflow

Commissioning typically consists of the following stages:

- 1 Checking the "Checklist before commissioning".
- 2 Performing a test run for the system.

19.2 Precautions when commissioning



NOTICE

Before starting up the system, the unit **MUST** be energised for at least 6 hours to avoid compressor breakdown during startup.



NOTICE

ALWAYS operate the unit with thermistors and/or pressure sensors/switches. If **NOT**, burning of the compressor might be the result.



NOTICE

ALWAYS complete the refrigerant piping of the unit before operating. If **NOT**, the compressor will break.



NOTICE

Cooling operation mode. Perform the test run in cooling operation mode so that stop valves failing to open can be detected. Even if the user interface was set to heating operation mode, the unit will run in cooling operation mode during 2-3 minutes (although the user interface will display the heating icon), and then automatically switch to heating operation mode.

**INFORMATION**

During the first running period of the unit, the required power may be higher than stated on the nameplate of the unit. This phenomenon is caused by the compressor, that needs a continuous run time of 50 hours before reaching smooth operation and stable power consumption.

19.3 Checklist before commissioning

<input type="checkbox"/>	You have read the complete installation and operation instructions described in the installer and user reference guide .
<input type="checkbox"/>	The indoor unit is properly mounted.
<input type="checkbox"/>	The outdoor unit is properly mounted.
<input type="checkbox"/>	The drain piping is properly installed and insulated, and drainage flows smoothly. Check for water leaks. Possible consequence: condensate water might drip.
<input type="checkbox"/>	The refrigerant pipes (gas and liquid) are installed correctly and thermally insulated.
<input type="checkbox"/>	There are NO refrigerant leaks .
<input type="checkbox"/>	There are NO missing phases or reversed phases .
<input type="checkbox"/>	The system is properly earthed and the earth terminals are tightened.
<input type="checkbox"/>	The fuses or locally installed protection devices are installed according to this document, and have NOT been bypassed.
<input type="checkbox"/>	The power supply voltage matches the voltage on the identification label of the unit.
<input type="checkbox"/>	There are NO loose connections or damaged electrical components in the switch box.
<input type="checkbox"/>	There are NO damaged components or squeezed pipes on the inside of the indoor and outdoor units.
<input type="checkbox"/>	The stop valves (gas and liquid) on the outdoor unit are fully open.

19.4 To perform a test run

**INFORMATION**

- Perform the test run according to the instructions in the connected user interface manual.
- The test run is only completed if there is no malfunction code displayed on the user interface.
- See the service manual for the complete list of error codes and a detailed troubleshooting guideline for each error.

**NOTICE**

Do **NOT** interrupt the test run.

20 Configuration

20.1 Field setting

Make the following field settings so that they correspond with the actual installation setup and with the needs of the user:

- Ceiling height
- Decoration panel type
- Airflow direction
- Air volume when thermostat control is OFF
- Time to clean air filter
- Number of the connected indoor units as simultaneous operation system
- Simultaneous operation system individual setting
- Computerised control (forced OFF and ON/OFF operation)

Setting: Ceiling height

This setting must correspond with the actual distance to the floor, capacity class and airflow directions.

- For 3-way and 4-way airflow (which require an optional blocking pad kit), see the installation manual of the optional blocking pad kit.
- For all-round air flow, use the table below.

If the distance to the floor is (m)		Then ⁽¹⁾		
FCAG35~71	FCAG100~140	M	C1/ SW	C2/ —
≤2.7	≤3.2	13 (23)	0	01
2.7<x≤3.0	3.2<x≤3.6			02
3.0<x≤3.5	3.6<x≤4.2			03

Setting: Decoration panel type

When installing or changing the decoration panel type, ALWAYS check if the correct values are set.

If the ... decoration panel is used	Then ⁽¹⁾		
	M	C1/SW	C2/—
Standard or self-cleaning	13 (23)	15	01
Design			02

Setting: Air flow direction

This setting must correspond with the actual used air flow directions. See the installation manual of the optional blocking pad kit and the manual of the user interface.

Default: 01 (= all-round air flow)

Example:

⁽¹⁾ Field settings are defined as follows:

- **M**: Mode number – **First number**: for group of units – **Number between brackets**: for individual unit
- **SW**: Setting number / **C1**: First code number
- **—**: Value number / **C2**: Second code number
- **■**: Default

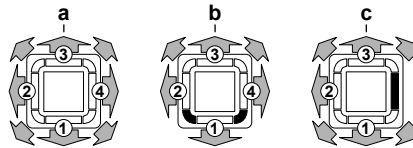

- a All-round air flow
- b 4-way air flow (all air outlets open, 2 corners closed) (optional blocking pad kit required)
- c 3-way air flow (1 air outlet closed, all corners open) (optional blocking pad kit required)

Setting: Air volume when thermostat control is OFF

This setting must correspond with the needs of the user. It determines the fan speed of the indoor unit during thermostat OFF condition.

- 1 If you have set the fan to operate, set the air volume speed:

	If you want		Then ⁽¹⁾		
	Outdoor unit		M	C1/SW	C2/—
	General	2MX/3MX/ 4MX/5MX			
During cooling operation	LL ⁽²⁾		12 (22)	6	01
	Setup volume ⁽²⁾				02
	OFF				03
	Monitoring 1 ⁽²⁾				04
	Monitoring 2 ⁽²⁾				05
During heating operation	LL ⁽²⁾	Monitoring 1 ⁽²⁾	12 (22)	3	01
	Setup volume ⁽²⁾	Monitoring 2 ⁽²⁾			02
	OFF				03
	Monitoring 1 ⁽²⁾				04
	Monitoring 3 ⁽²⁾				05

Setting: Time to clean air filter

This setting must correspond with the air contamination in the room. It determines the interval at which "Time to clean filter" notification is displayed on the user interface.

⁽¹⁾ Field settings are defined as follows:

- **M**: Mode number – **First number**: for group of units – **Number between brackets**: for individual unit
- **SW**: Setting number / **C1**: First code number
- **—**: Value number / **C2**: Second code number
- **■**: Default

⁽²⁾ Fan speed:

- **LL**: Low fan speed (set during thermostat OFF)
- **L**: Low fan speed (set by the user interface)
- **Setup volume**: The fan speed corresponds to the speed the user has set using the fan speed button on the user interface.
- **Monitoring 1, 2, 3**: The fan is OFF, but runs for a short time every 6 minutes to detect the room temperature by **LL** (Monitoring 1), **Setup volume** (Monitoring 2) or **L** (Monitoring 3).

If you want an interval of... (air contamination)	Then ⁽¹⁾		
	M	C1/ SW	C2/—
±2500 h (light)	10 (20)	0	01
±1250 h (heavy)			02
No notification		3	02

Setting: Number of the connected indoor units as simultaneous operation system



INFORMATION

Pair/Twin/Triple/Double Twin - not needed to set anymore. ODU can detect this setting automatically.

For simultaneous operation system mode made following field setting:

If the system mode is...	Then ⁽¹⁾		
	M	C1/SW	C2/—
Pair (1 unit)	11 (21)	0	01
Twin (2 units)			02
Triple (3 units)			03
Double twin (4 units)			04

When using in **simultaneous operation** system mode, refer to “simultaneous operation system individual setting” section to set master and slave units separately.

Setting: Simultaneous operation system individual setting

Perform the following procedure when setting the master and slave unit separately.

1 Change setting:

If you want...	Then ⁽¹⁾		
	M	C1/SW	C2/—
Unified setting	11 (21)	1	01
Individual setting			02

- 2 Perform field setting for the master unit.
- 3 Turn off main power supply.
- 4 Detach user interface from the master unit and connect it to the slave unit.
- 5 Turn on the main power supply switch and set individual setting to 11(21)-1-02.
- 6 Perform field setting for slave unit.
- 7 Turn off the main power supply.
- 8 If there is more than one slave unit, repeat setting for each.

⁽¹⁾ Field settings are defined as follows:

- **M**: Mode number – **First number**: for group of units – **Number between brackets**: for individual unit
- **SW**: Setting number / **C1**: First code number
- **—**: Value number / **C2**: Second code number
- **■**: Default

9 Detach user interface from the slave unit and reattach to the master unit.



INFORMATION

- You do NOT need to rewire the user interface from the master unit if the optional user interface for slave unit is used. However, remove the wires attached to the user interface of the master unit.
- After the slave unit is set up, re-connect the user interface to master unit.
- The system does not operate properly when two or more user interfaces are attached in the simultaneous operation system mode.

Setting: Computerised control (forced OFF and ON/OFF operation)

Wire specifications and how to perform wiring

Connect input from outside to terminals T1 and T2 of the terminal block for user interface (there is no polarity).

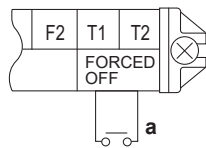

a Input A

Wire specification	
Wire specification	Sheathed vinyl cord or cable (2 wire)
Gauge	0.75~1.25 mm ²
External terminal	Contact that can ensure the minimum applicable load of 15 V DC, 10 mA.

Actuation

Forced OFF	ON/OFF operation	Input from protection device
Input ON stops operation (impossible by user interface)	Input OFF → ON: Turns the unit ON	Input ON enables control by user interface
Input OFF enables control by user interface	Input ON → OFF: Turns the unit OFF	Input OFF stops operation: Triggers A0 error code

How to select FORCED OFF and ON/OFF OPERATION

- Turn on the power and then use the user interface to select operation.
- Change setting:

If you want...	Then ⁽¹⁾		
	M	C1/SW	C2/—
Forced OFF	12 (22)	1	01
ON/OFF operation			02
Input from protection device			03

⁽¹⁾ Field settings are defined as follows:

- M**: Mode number – **First number**: for group of units – **Number between brackets**: for individual unit
- SW**: Setting number / **C1**: First code number
- : Value number / **C2**: Second code number
- : Default

21 Hand-over to the user

Once the test run is finished and the unit operates properly, make sure the following is clear for the user:

- Make sure that the user has the printed documentation and ask him/her to keep it for future reference. Inform the user that he/she can find the complete documentation at the URL mentioned earlier in this manual.
- Explain to the user how to properly operate the system and what to do in case of problems.
- Show the user what to do for the maintenance of the unit.

22 Troubleshooting

22.1 Solving problems based on error codes

If the unit runs into a problem, the user interface displays an error code. It is important to understand the problem and to take measures before resetting an error code. This should be done by a licensed installer or by your local dealer.

This chapter gives you an overview of most possible error codes and their descriptions as they appear on the user interface.



INFORMATION

See the service manual for:

- The complete list of error codes
- A more detailed troubleshooting guideline for each error

22.1.1 Error codes: Overview

In case other error codes appear, contact your dealer.

Code	Description
<i>P0</i>	External protection device activated
<i>P1</i>	Malfunction of indoor unit PCB
<i>P3</i>	Drain level control system abnormality
<i>P4</i>	Malfunction of freezing protection
<i>P5</i>	High pressure control in heating, freeze-up protection control in cooling
<i>P6</i>	Malfunction of fan motor
<i>P7</i>	Malfunction of swing flap motor
<i>P8</i>	Malfunction of power supply or AC input overcurrent
<i>PF</i>	Malfunction of a humidifier system
<i>PH</i>	Malfunction of dust collector of air cleaner
<i>PJ</i>	Malfunction of capacity setting (Indoor unit PCB)
<i>E1</i>	Failure of transmission (between indoor unit PCB and sub PCB)
<i>E4</i>	Malfunction of liquid pipe thermistor for heat exchanger
<i>E5</i>	Malfunction of gas pipe thermistor for heat exchanger
<i>E6</i>	Malfunction of gas pipe thermistor for heat exchanger
<i>E9</i>	Malfunction of suction air thermistor
<i>ER</i>	Malfunction of discharge air thermistor
<i>EJ</i>	Room temperature thermistor in remote controller abnormality

23 Disposal



NOTICE

Do NOT try to dismantle the system yourself: dismantling of the system, treatment of the refrigerant, oil and other parts **MUST** comply with applicable legislation. Units **MUST** be treated at a specialised treatment facility for reuse, recycling and recovery.





















24 Technical data

- A **subset** of the latest technical data is available on the regional Daikin website (publicly accessible).
- The **full set** of the latest technical data is available on the Daikin Business Portal (authentication required).

24.1 Wiring diagram

24.1.1 Unified wiring diagram legend

For applied parts and numbering, refer to the wiring diagram on the unit. Part numbering is by Arabic numbers in ascending order for each part and is represented in the overview below by "*" in the part code.

Symbol	Meaning	Symbol	Meaning
	Circuit breaker		Protective earth
			Noiseless earth
			Protective earth (screw)
	Connection		Rectifier
	Connector		Relay connector
	Earth		Short-circuit connector
	Field wiring		Terminal
	Fuse		Terminal strip
	Indoor unit		Wire clamp
	Outdoor unit		Heater
	Residual current device		

Symbol	Colour	Symbol	Colour
BLK	Black	ORG	Orange
BLU	Blue	PNK	Pink
BRN	Brown	PRP, PPL	Purple
GRN	Green	RED	Red
GRY	Grey	WHT	White
SKY BLU	Sky blue	YLW	Yellow

Symbol	Meaning
A*P	Printed circuit board
BS*	Pushbutton ON/OFF, operation switch
BZ, H*O	Buzzer
C*	Capacitor

Symbol	Meaning
AC*, CN*, E*, HA*, HE*, HL*, HN*, HR*, MR*_A, MR*_B, S*, U, V, W, X*A, K*R_*, NE	Connection, connector
D*, V*D	Diode
DB*	Diode bridge
DS*	DIP switch
E*H	Heater
FU*, F*U, (for characteristics, refer to PCB inside your unit)	Fuse
FG*	Connector (frame ground)
H*	Harness
H*P, LED*, V*L	Pilot lamp, light emitting diode
HAP	Light emitting diode (service monitor green)
HIGH VOLTAGE	High voltage
IES	Intelligent eye sensor
IPM*	Intelligent power module
K*R, KCR, KFR, KHuR, K*M	Magnetic relay
L	Live
L*	Coil
L*R	Reactor
M*	Stepper motor
M*C	Compressor motor
M*F	Fan motor
M*P	Drain pump motor
M*S	Swing motor
MR*, MRCW*, MRM*, MRN*	Magnetic relay
N	Neutral
n=*, N=*	Number of passes through ferrite core
PAM	Pulse-amplitude modulation
PCB*	Printed circuit board
PM*	Power module
PS	Switching power supply
PTC*	PTC thermistor
Q*	Insulated gate bipolar transistor (IGBT)
Q*C	Circuit breaker
Q*DI, KLM	Earth leak circuit breaker
Q*L	Overload protector

Symbol	Meaning
Q*M	Thermo switch
Q*R	Residual current device
R*	Resistor
R*T	Thermistor
RC	Receiver
S*C	Limit switch
S*L	Float switch
S*NG	Refrigerant leak detector
S*NPH	Pressure sensor (high)
S*NPL	Pressure sensor (low)
S*PH, HPS*	Pressure switch (high)
S*PL	Pressure switch (low)
S*T	Thermostat
S*RH	Humidity sensor
S*W, SW*	Operation switch
SA*, F1S	Surge arrester
SR*, WLU	Signal receiver
SS*	Selector switch
SHEET METAL	Terminal strip fixed plate
T*R	Transformer
TC, TRC	Transmitter
V*, R*V	Varistor
V*R	Diode bridge, Insulated-gate bipolar transistor (IGBT) power module
WRC	Wireless remote controller
X*	Terminal
X*M	Terminal strip (block)
Y*E	Electronic expansion valve coil
Y*R, Y*S	Reversing solenoid valve coil
Z*C	Ferrite core
ZF, Z*F	Noise filter

25 Glossary

Dealer

Sales distributor for the product.

Authorised installer

Technical skilled person who is qualified to install the product.

User

Person who is owner of the product and/or operates the product.

Applicable legislation

All international, European, national and local directives, laws, regulations and/or codes that are relevant and applicable for a certain product or domain.

Service company

Qualified company which can perform or coordinate the required service to the product.

Installation manual

Instruction manual specified for a certain product or application, explaining how to install, configure and maintain it.

Operation manual

Instruction manual specified for a certain product or application, explaining how to operate it.

Accessories

Labels, manuals, information sheets and equipment that are delivered with the product and that need to be installed according to the instructions in the accompanying documentation.

Optional equipment

Equipment made or approved by Daikin that can be combined with the product according to the instructions in the accompanying documentation.

Field supply

Equipment NOT made by Daikin that can be combined with the product according to the instructions in the accompanying documentation.

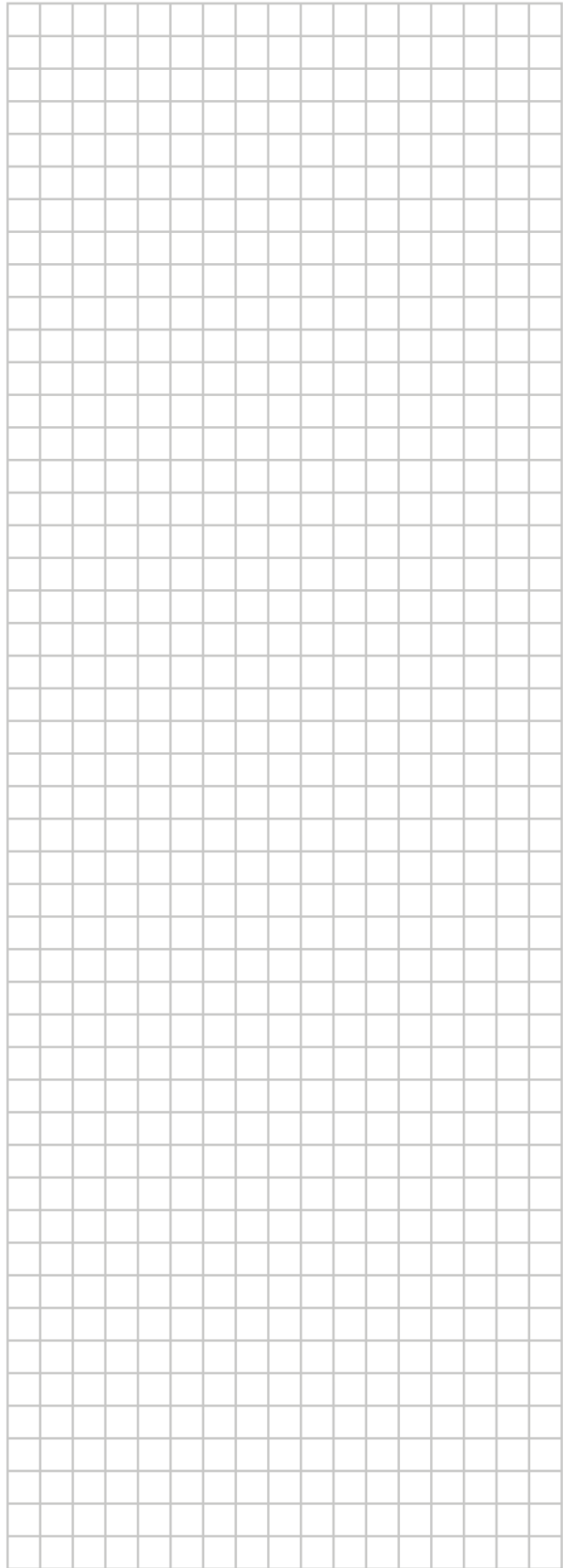
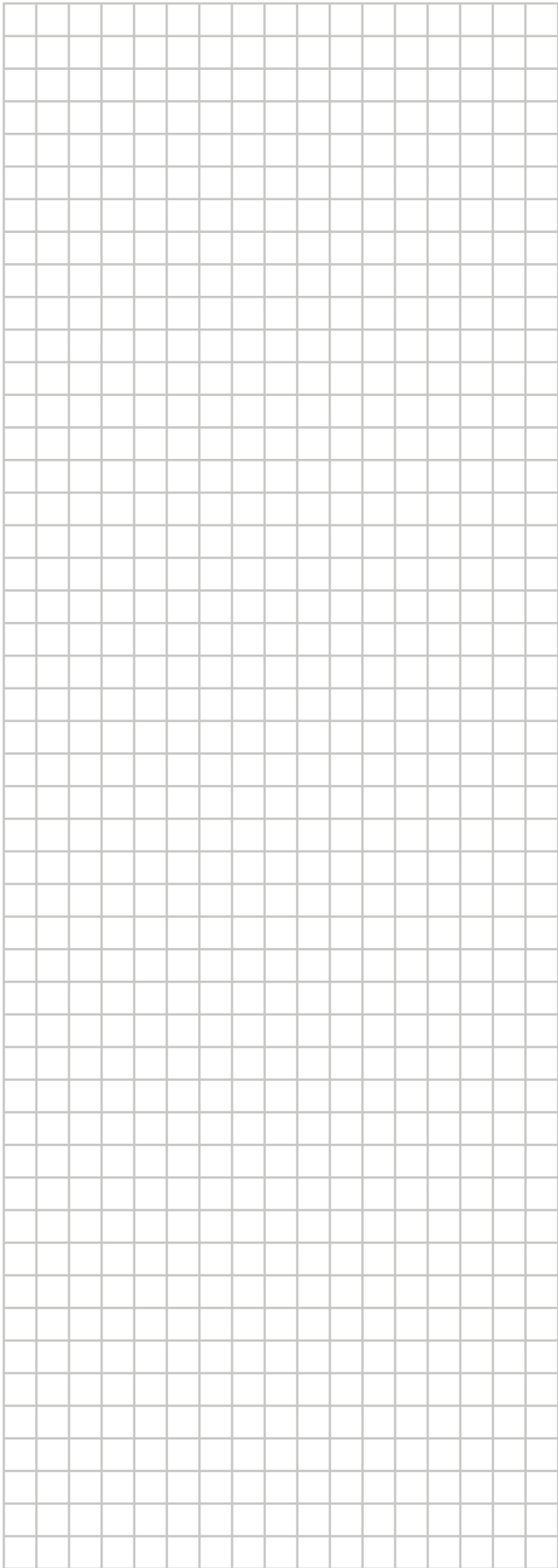
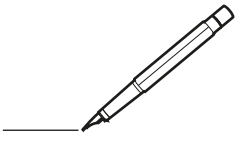

ERC

DAIKIN INDUSTRIES CZECH REPUBLIC s.r.o.

U Nové Hospody 1155/1, 301 00 Plzeň Skvrňany, Czech Republic

DAIKIN EUROPE N.V.

Zandvoordestraat 300, B-8400 Oostende, Belgium

Copyright 2018 Daikin

4P561448-1C 2025.07